

Presented at:

International System Dynamics Conference  
July 26-30, 2009  
Albuquerque, New Mexico, USA

***The “HealthBound” Policy Simulation Game:  
An Adventure in US Health Reform***

**Bobby Milstein**

Centers for Disease Control and Prevention, Atlanta, GA  
[bmilstein@cdc.gov](mailto:bmilstein@cdc.gov)

**Jack Homer**

Homer Consulting, Voorhees, NJ  
[jhomer@comcast.net](mailto:jhomer@comcast.net)

**Gary Hirsch**

Consultant, Wayland, MA  
[gbhirsch@comcast.net](mailto:gbhirsch@comcast.net)

The name “HealthBound” is used courtesy of Associates & Wilson.

The findings and conclusions in this article are those of the authors and do not necessarily represent the official position of the Centers for Disease Control and Prevention.

**Abstract**

With support from the U.S. Centers for Disease Control and Prevention, we developed the *HealthBound* policy simulation game for those wanting to experience the possibility of transforming our troubled health system. The game’s simulator tracks movement of the U.S. population among states of health, risk behavior, environmental exposures, and socioeconomic status. The model is quantified based on publicly available data from the early 2000s as well as studies from the professional literature on health care utilization and programmatic impact. Players try to steer the country’s health system toward greater levels of health, equity, and cost-effectiveness. The goals are difficult to achieve, in part, because the game includes resource constraints, time delays, and side effects of intervention similar to those of the actual health system. The game allows tests of many types of interventions, individually or in combination, and at different points in time over a 25-year time horizon. Various types of output screens allow players to trace the precise reasons for their successes or failures. Those who aspire to lead change on a national scale, or in their own sphere of influence, may benefit by first testing and refining their ideas in this realistic, but simplified version of the U.S. health system, and learning its core lessons.

## Introduction

The U.S. health system has been evolving in response to major interventions for over seven decades, and it is again poised for further transformation. One difficulty in defining an effective strategy is that different stakeholders typically promote their own ideas, while overlooking or undervaluing other perspectives. The focus tends to be on solving one problem at a time, such as lack of access to health care services, poor quality services, or high cost. Even health policy analysts typically do not think about improving the performance of the system as a whole across many dimensions simultaneously. Instead, the short-term, direct effects of an intervention are hailed as “solutions” while indirect effects elsewhere in the system, potential sources of policy resistance, and implementation delays are ignored. The debate also suffers from an overwhelming emphasis on health care delivery and the downstream consequences of disease. Investments in prevention (usually in the form of clinical preventive services) are increasingly mentioned, but few proposals display a strong commitment to protecting health and assuring health equity.

The *HealthBound* Policy Simulation Game provides a practice field in which players can experiment with various interventions, explore the strengths and limitations of each, and get a sense of which combinations offer the greatest advantage. With support from the Centers for Disease Control and Planning (CDC), we developed the *HealthBound* game for those wanting to experience the possibility of transforming our troubled health system. Players are equipped with the power to navigate the U.S. health system toward greater levels of health, equity, and cost-effectiveness, if only they can discover how.

The players’ goals are difficult to achieve, in part, because the game includes resource constraints, time delays, and side effects of intervention similar to those of the actual health system. These complicating features must be understood in order to succeed. The game allows tests of single interventions, as well as a high degree of creativity in mixing them for better effects. There is also a transparent causal structure that allows players to identify the precise reasons for patterns observed in the game. Players learn by simulated experience and by tracing through the reasons for their successes or failures.

Those who aspire to lead change on a national scale, or in their own sphere of influence, may benefit by first testing and refining their ideas in this realistic, but simplified version of the U.S. health system. They may play out popular proposals, explore new ideas, rule out ineffective strategies, and gather support for more promising scenarios. The game teaches essential lessons about how the health system works and establishes a productive frame for finding a viable way forward. We are working with the CDC to use the game as the basis for a series of *Wayfinding Dialogues* in which stakeholders across the country consider what they can do to help steer a course toward a healthier, more equitable, and more prosperous future.

## Design

The game integrates data and findings from a wide variety of studies on factors affecting health system performance, including our prior analysis of U.S. health system dynamics 1960 to the present (Homer, Hirsch, and Milstein 2007). Figure 1 shows the major elements of the health

system and how they are connected. Figure 2 presents a somewhat more detailed map of causal pathways represented in the game and shows where each intervention option fits within the larger health system. Two facts are immediately obvious: (1) all parts of this system, often considered separately in popular discourse and in analytic studies, are causally connected; and (2) there are more processes at work—as well as more intervention options available—than one might infer from many discussions of health care reform. Indeed, adequate representation of the variables and relationships identified in Figure 2 requires hundreds of equations. The model underlying the *HealthBound* game contains about 800 calculated variables, 150 constants, and 19 intervention or gaming variables. A technical appendix that describes the model in detail is available. See the Note at the end of this paper for information on how to access the appendix.

**Figure 1:** Major Elements Represented in the *HealthBound* game<sup>1</sup>

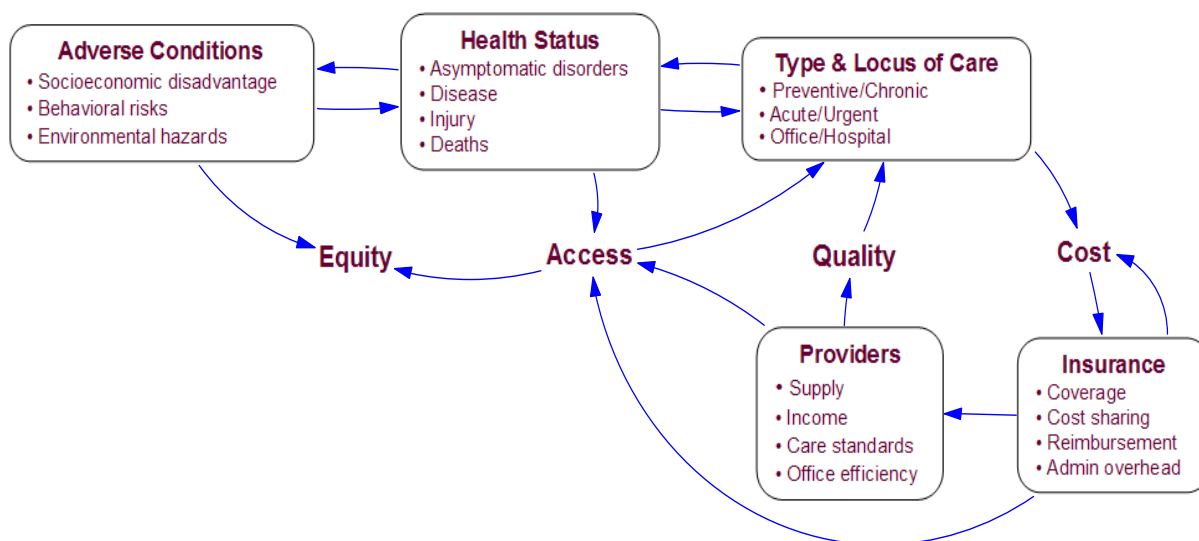

### Causal Pathways, Scoring Criteria, and Intervention Options

As indicated in Figure 2, the game’s simulator tracks the entire U.S. population and its movement among states of health, risk behavior, environmental exposures, and socioeconomic advantage or disadvantage. Blue arrows indicate same-direction effects (e.g., more environmental hazards lead to more disease and injury), while green arrows indicate opposite-direction effects (e.g., greater sufficiency of primary care providers leads to less use of specialists and hospitals for non-urgent care). Scoring criteria are in red and bolded. Interventions are in italics.

<sup>1</sup> Many variables in the game are tracked separately by socioeconomic status, including those related to behavioral risks, environmental hazards, health status, type and locus of care received, the number of primary care providers, access to health care, insurance coverage, and cost sharing.

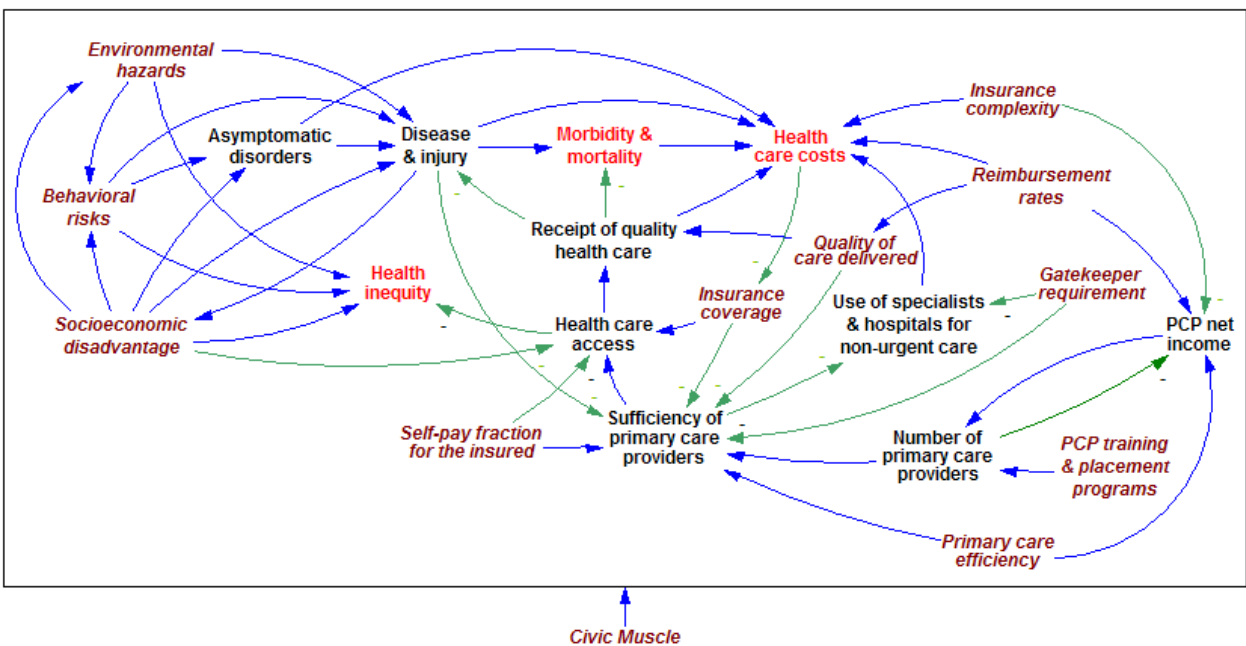
**Figure 2** Major Causal Relationships in the *HealthBound* game

The basic causal logic is as follows: Many health problems have their genesis in unhealthy behaviors and hazardous and stressful environments. Socioeconomic disadvantage worsens all of these social determinants of health. The disadvantaged also have worse access to regular office-based health care than do the advantaged, due to less insurance coverage and less sufficiency of primary care providers (PCPs) to meet patient demand. This insufficiency of office-based care leads to increased use of hospital emergency departments for non-urgent care. The insufficiency is largely related to relatively low PCP incomes, especially for PCPs who serve the disadvantaged. Another factor affecting health outcomes, for both the disadvantaged and the advantaged, is the quality of care delivered, describing the extent to which providers follow guidelines for best practice with regard to screening, monitoring, and treatment. Quality of care may suffer when insurance reimbursement rates are not adequate.

Players attempt to achieve the best results across four criteria simultaneously. They must (1) save lives; (2) improve well-being; (3) achieve health equity; and (4) lower health care costs per capita, all the while being conscious of total intervention spending or the number of simultaneous interventions. The game tracks these scorecard variables and many others over 30 years: beginning with a 5-year comparison period, followed by 25 years during which players may intervene.

Players may employ several types of intervention, alone or in combination, to achieve their goals. These include (1) expanding insurance coverage; (2) improving quality of care; (3) reducing insurance complexity (e.g. through standardization of benefits or a single payer approach); (4) expanding the supply of primary care providers, particularly for disadvantaged populations, through training and placement programs and associated incentives; (5) improving

primary care efficiency (allowing providers to operate at lower cost and better use their time); (6) changing reimbursement rates to physicians or hospitals; (7) requiring gatekeeper approval for specialist services; (8) changing the self pay fraction for those who have insurance (including self-paid premiums, co-pays, and deductibles); (9) enabling healthier behaviors (e.g., reducing tobacco use); (10) building safer environments (e.g., reducing air pollution); (11) creating pathways to advantage (e.g., through education, job training, living wage policies); and (12) strengthening civic muscle to enable more effective implementation of the other interventions. Many of these general interventions can be further tailored by focusing on particular areas of the system (such as office-based versus hospital services, or the disadvantaged versus advantaged sub-group).

### **Population Stocks and Flows**

It is useful to consider the model's core stock-and-flow population structure and the determinants of flows among the population stocks. The population stocks and flows associated with health status and socioeconomic status are diagrammed in Figure 3. Two levels of socioeconomic status are considered: Advantaged (Adv) and Disadvantaged (Disadv). Three levels of health status are represented: No significant health problem (NSHP), Asymptomatic disorder but no disease or injury (AD no DI), and Disease or injury (DI). (Many people in the Disease or injury stock also have an asymptomatic disorder; i.e., DI with AD. Asymptomatic disorders include most prominently hypertension, high cholesterol, and pre-diabetes.)

Deaths occur at a rate determined by the urgent event rate (which can be reduced by improved disease and injury management) and the fatal fraction of urgent events (which can be reduced by improved quality of urgent care). Some people with DI recover back to the NSHP and the AD-no-DI stocks.

Figure 4 shows how the rates of onset to AD (from NSHP) and DI (from NSHP or from AD-no-DI) can vary with other factors. Changes in the prevalence of unhealthy behavior affect the rate of onset of AD; for example, poor nutrition or inadequate physical activity affect the onset of hypertension, high cholesterol, and pre-diabetes. Changes in unhealthy behavior also affect the rate of onset of DI; for example, smoking affects the onset of lung cancer and emphysema. The onset of DI is also affected by the fraction of the population living in an unsafe environment; for example, diseases due to pollution, or injuries due to unsafe buildings or to violent crime. For people who already have AD, the risk of moving from to DI can be reduced through improved management of asymptomatic disorders. And for people who already have DI, the risk of urgent and acute events and acute events (not shown in Figure 4) can be reduced through improved management of disease and injury.

**Figure 3** Population Stock and Flow Structure of *HealthBound* Model

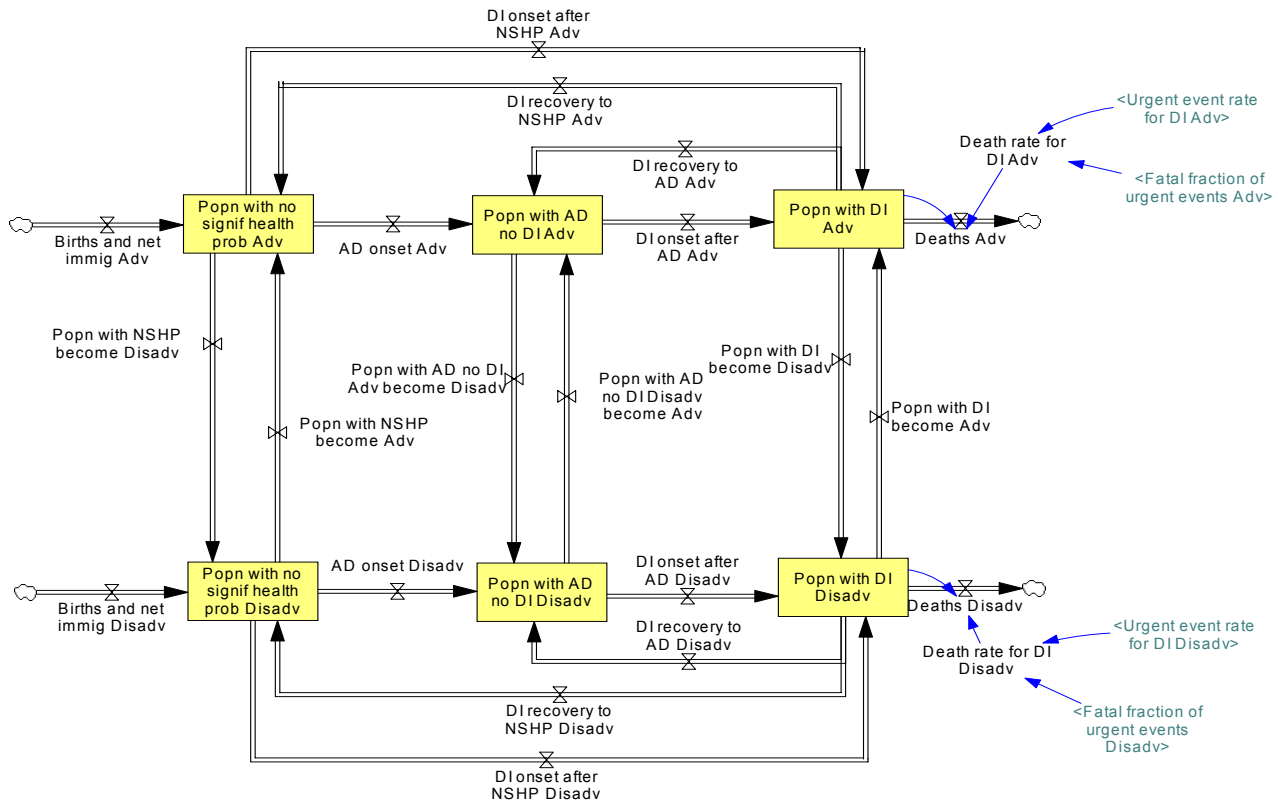

**Starting Conditions**

A number of factors were excluded from the game on the premise that our health system would remain troubled even if certain ongoing trends were somehow frozen or eliminated. These include the adoption of new technologies, the "tug of war" over billing between insurers and providers, population growth and aging, the rise of defensive medicine, globalization of the medical marketplace, the medicalization of common ailments through direct-to-consumer advertising, increasing regulations on tobacco use, and trends in employment, transportation, recreational options, and food options. We have previously shown how some of these factors can create instability in the health system and cause costs to grow (see Homer, Hirsch, and Milstein 2007). But, for the game, we defined a system starting in a dynamic equilibrium, with all outcome variables sitting close to where they were in real life around the year 2003—and unchanging. Players must identify the most powerful drivers of system behavior and use that knowledge to move from an initially undesirable state toward one that is healthier, more equitable, and more cost-effective. This setup—where many features are intentionally held constant—allows us to rest the game on processes that are less transitory and lets players better understand the results of their decisions.

**Figure 4** Structure for Onset of Asymptomatic Disorders and Disease and Injury

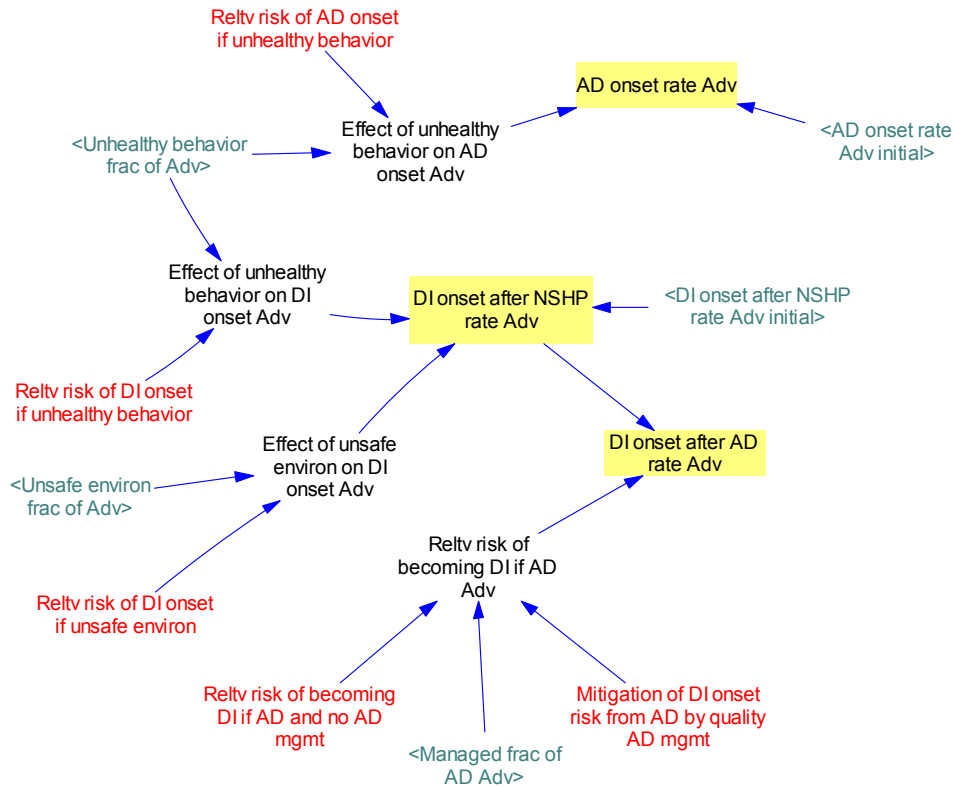

### Empirical Foundations

As stated above, the game integrates data and findings from earlier studies on factors affecting health system performance. Because of its broad sweep, most variables are defined at a high level of aggregation. For example, the game does not consider individual types of disease or injury, but rather combines them all into a single measure of prevalence based on national surveys like the National Health Interview Survey and the National Health and Nutrition Examination Survey. Such aggregate metrics have been shown to be reliable predictors of health service utilization and health outcomes. In general, quantification of elements in the game is based on a variety of publicly available data from the Census, Vital Statistics, national health surveys, the National Health Expenditures database, and studies from the professional literature on health care utilization and programmatic impact. We expect to refine some concepts and estimates as we gather more information from research and subject matter experts, but aggregated representations will always be necessary to make the analysis tractable and consonant with available data.

The main data sources that were used to formulate the current game are as follows:

- Behavioral Risk Factor Surveillance System
- National Ambulatory Medical Care Survey
- National Health Expenditure Accounts
- National Health Interview Survey
- National Health and Nutrition Examination Survey
- National Hospital Discharge Survey
- National Vital Statistics Reports
- U.S. Census

### **Why a Game?**

Why was it necessary to develop *HealthBound* as a game rather than simply presenting a model and results of a number of simulations? Models help us describe the structure of complex systems, understand relationship between structure and behavior, and ask “what if?” questions using a consistent framework. But it is hard to develop insights into the behavior of a complex system through slide presentations and written reports. Interactive demonstrations with models are better, but much of the learning still remains in the head of the model builder. Managers and policymakers need a means of exploring the system themselves and constructing their own understanding. Games use a model, interface, and well-thought out learning experience to give them this capability.

Games entertain and engage decision makers by relying on both cognitive and experiential learning. They allow players to experiment with their own strategies, test and sharpen their intuitions about how the system works, appreciate the strategic implications of their actions, including unintended consequences, think systemically (in general and especially about recommended interventions), and develop a shared understanding with diverse stakeholders.

Games remove the model builder as an expert intermediary. They enable experiential learning and let players reach their own conclusions. In a situation such as health reform where people have entrenched attitudes and tend to only see parts of the problem, the learning experience provided by a game can be especially useful for unfreezing attitudes and expanding frameworks.

Gaming has been used extensively in the public policy arena and in health care specifically. Games such as *Mastering the Transition to Capitation* (Kemeny and Hirsch, 1994) and the *Health Care Microworld* (Hirsch and Immediato, 1998, 1999) have helped people learn how to manage health care systems more effectively. *Friday Night at the ER* (2009) has helped people understand systems concepts, such as the idea that problems with overcrowding in the ER may be the result of a backup from inpatient units. A game called *SimHealth* also allowed players to experiment with different approaches to health care (Strategy wiki, 2009). A group called Games-For-Health encompasses many developers who focus on games that help individuals



manage their chronic illness or maintain healthier habits through techniques such as “exergaming” (Games for Health, 2009). Gaming has also been used extensively to support public health functions such as emergency preparedness and responding to pandemics (Le Claire, 2007).

### **A Brief Tour of the *HealthBound* Game**

The best way to understand how *HealthBound* is played is to take a brief tour and see how a typical policy experiment would be done. Many people equate health reform with universal health insurance coverage, as if coverage alone would somehow cure most of the system’s ills. A logical starting place, therefore, is to simulate a dramatic expansion of health insurance coverage. As shown in Figure 2, the direct effect is to increase Health Care Access and, indirectly, the Receipt of Quality Health Care and, ideally, Health Equity. What will happen? A player would conduct this experiment by checking the boxes for Expand Insurance Coverage on a screen shown in Figure 5.

After clicking on the “Submit Decisions” button, the simulation will begin to advance. Users have the ability to move forward 5 years at a time, making changes as they go, or to move through the remainder of the simulation with the same interventions in place. A Scorecard screen, shown in Figure 6, displays selected changes after each interval (in this case at the end of 15 years). Other than a change in the fraction of the population uninsured, the key measures have changed very little. At this point one could decide to add other interventions, but let’s stay with expanded insurance coverage alone for the remainder of the simulation.

Figure 7 shows the Progress Report screen at the end of the simulation. There still has been surprisingly little movement in the key measures of health status, health equity, and health care costs. Health measures have improved by 2% (fewer deaths and unhealthy days) while costs have gone up by 2% and inequity has actually gotten worse, increasing by 1%. Why has expanding insurance coverage been so ineffective in moving the system and made things a bit worse for those it should help?

The game also gives users the tools to drill down into the model and understand the causes of these high level results. A screen labeled “The Big Picture” displays the same causal diagram seen in Figure 2. Rolling the cursor over any element of that diagram will pop up a set of related graphs. For example, rolling over the element “Sufficiency of primary care providers” reveals the graphs shown in Figure 8. These graphs show that the expanded insurance coverage increased demand for services, which reduced the sufficiency of primary care providers (especially those serving the disadvantaged population), and in turn elevated the fraction of preventive and chronic care demand not being accommodated. People in the disadvantaged subgroup were not able to make the same (small) gains as the advantaged, so the summary measure of health equity suffers as a result.

Figure 5 Interventions Screen with Insurance Expansion Selected

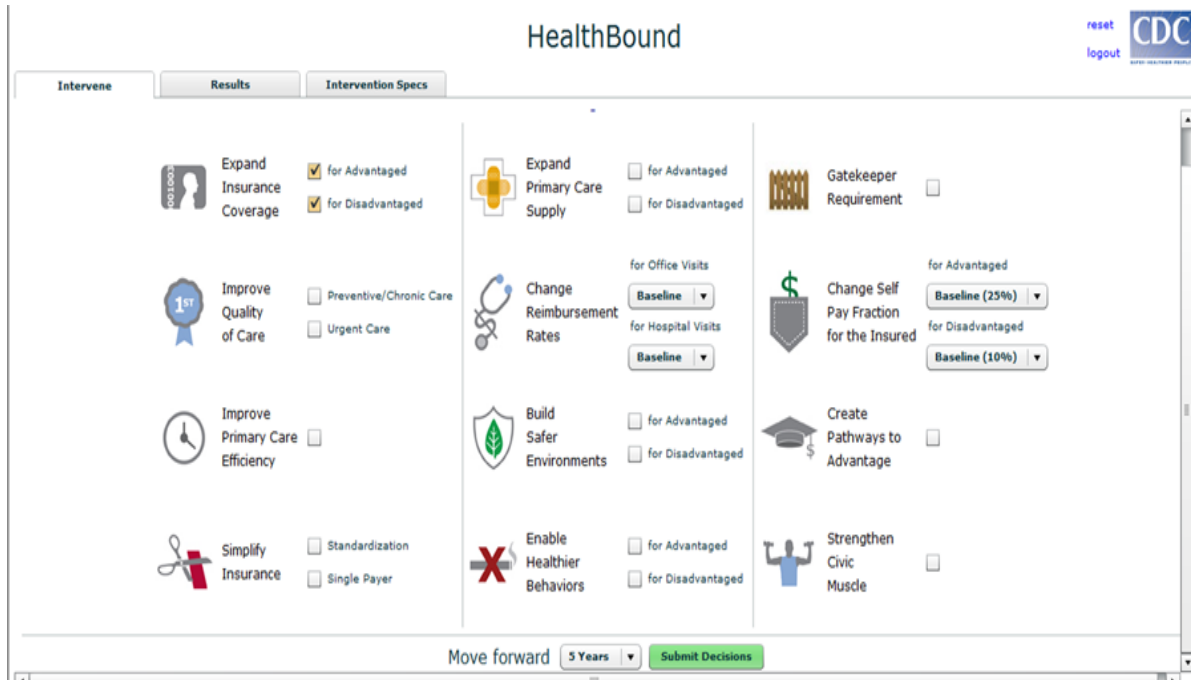
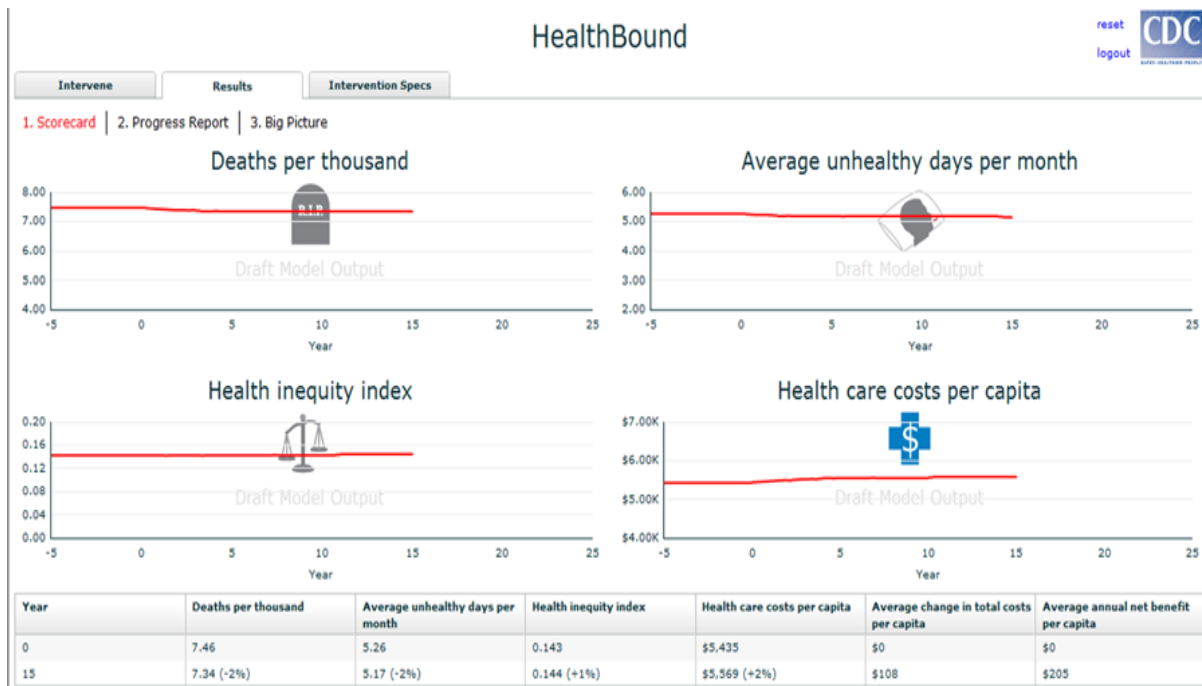
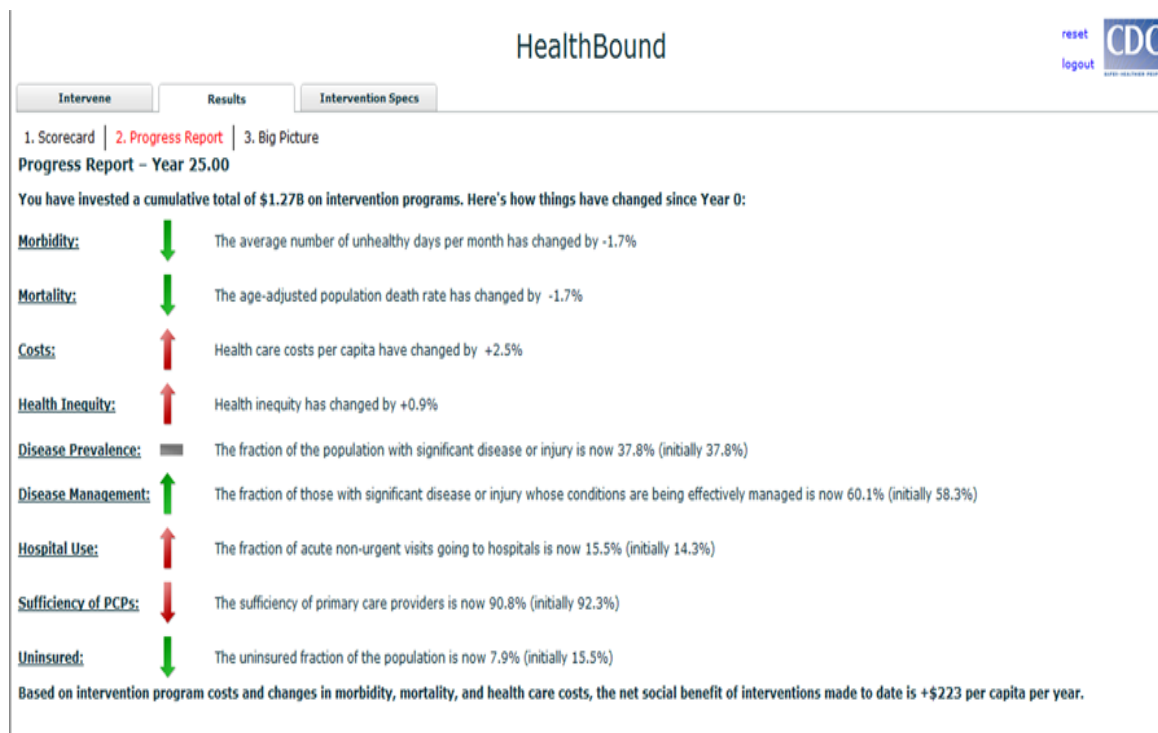

Figure 6: Scorecard Screen at End of 15 Years



**Figure 7:** Progress Report Screen at End of 25 Years

Rolling over the element “Use of specialists and hospitals for non-urgent Care” reveals the graphs shown in Figure 9. Figure 9 shows how the insufficiency of PCP capacity for the disadvantaged also contributes to higher per capita cost by causing more care for the disadvantaged to shift from physicians’ offices and Community Health Centers to hospital emergency rooms and outpatient clinics.

Seeing these results, the user would come to understand the limitations of expanding insurance coverage alone and then have the opportunity to try a number of different combinations of interventions to see which ones could help overcome the limitations and produce better outcomes.

### More Lessons Players May Learn

The game remains a work-in-progress and is being used to support dialogues with a widening circle of stakeholders. It has helped these stakeholders learn some important lessons about the health system and its often counterintuitive behavior. Future refinements of the game will help sharpen and extend the lessons that can be learned, especially with regard to combinations and sequencing or timing of interventions. Some of the key lessons learned thus far are as follows:

Figure 8: “Big Picture” Screen at End of 25 Years, Graphs Related to PCP Sufficiency

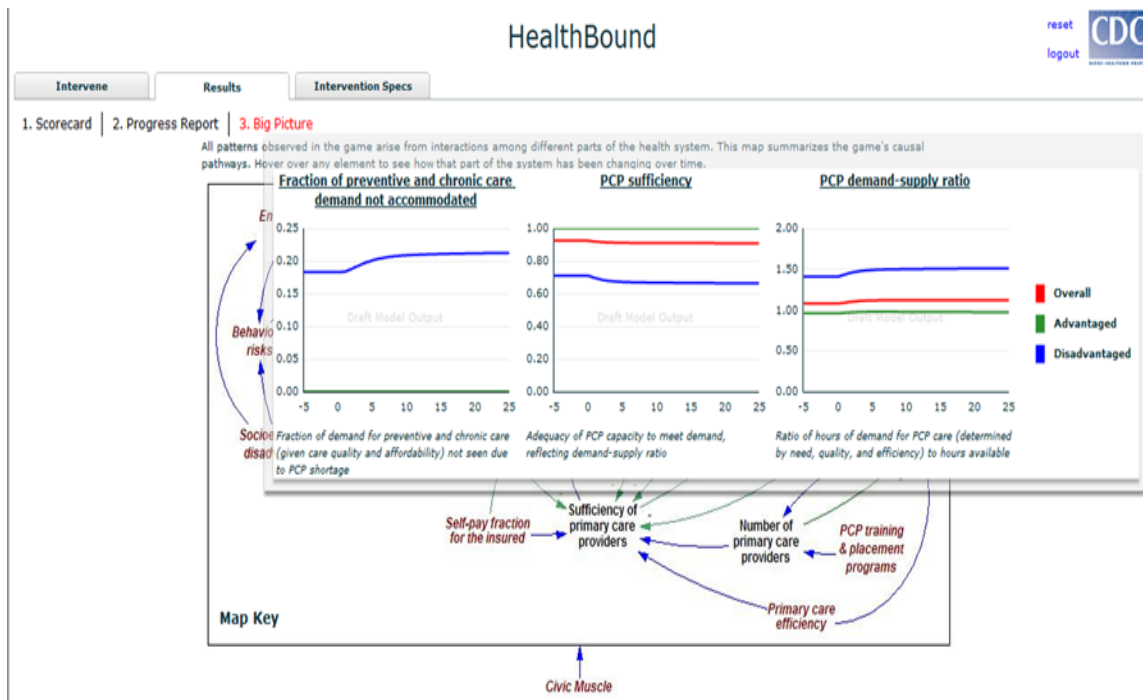
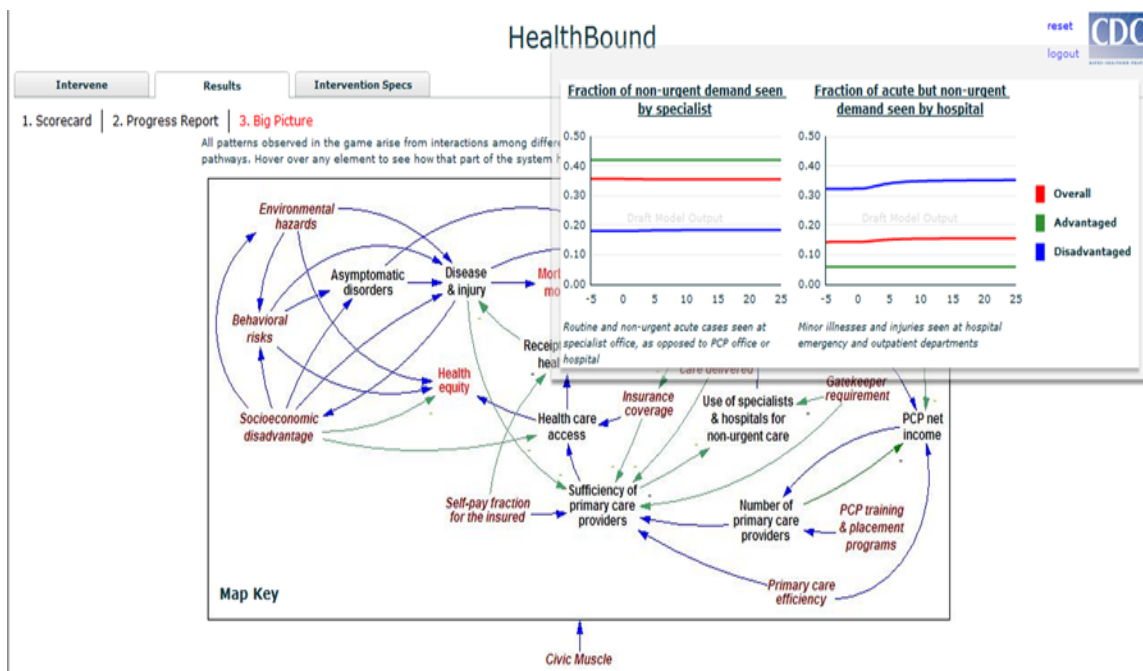

Figure 9: “Big Picture” Screen at End of 25 Years, Graphs Related to Use of Specialists and Hospitals for Non-Urgent Care



***Universal Coverage***

Universal insurance coverage reduces morbidity and mortality, but it does not reduce overall health care costs. Also, perhaps surprisingly, it does not reduce the inequity between the advantaged and the disadvantaged. When coverage is extended to all, the additional demand is fairly easily absorbed by providers to the advantaged, but not so for the disadvantaged. The disadvantaged may all be insured now, but they encounter even greater difficulty than before in getting seen regularly for their chronic conditions.

***Improving Quality of Care***

Increasing the quality of chronic and preventive care by office-based primary care physicians and specialists can produce an even greater reduction in morbidity and mortality than that achieved by universal coverage, because the quality improvement applies to a much larger segment of the population. But like universal coverage, quality improvement does not reduce health care costs, because it leads to more provider visits and more use of medications. Also, quality improvement worsens health inequity. This is again because the additional demand for visits can be fairly easily absorbed by providers to the advantaged, but not so for the disadvantaged.

***Cutting Reimbursement***

Reducing reimbursements to office-based providers offers the promise of lowering health care costs. But it also has the tendency to diminish quality of care. The reduction in quality quickly leads to greater morbidity and mortality, particularly among those with chronic diseases. The increase in morbidity leads to more office and hospital visits, which cost money, undercutting the initial reduction in costs. Also, the loss of income to providers causes their numbers to dwindle over time, leading to further worsening of morbidity and mortality. As a result, any initial reduction in costs is ultimately negated.

***Improving Primary Care Capacity***

The game points to two strategies that could work to improve health equity and reduce health care costs. One of them is to increase PCP capacity for the disadvantaged, which can be done in one of three ways: making PCP office operations more efficient, improving PCP insurance reimbursements, or offering more scholarships and other incentives for medical students who commit to work with the disadvantaged after they graduate. With greater PCP capacity, the health care demands of the disadvantaged may be better met in provider offices rather than in hospital emergency departments, thereby reducing health care costs.

***Upstream Strategies***

A second approach to improve equity and reduce costs is to reduce disease disparities that result from the greater vulnerability to affliction experienced by the disadvantaged. This “upstream” approach entails either creating safer environments and enabling healthier behaviors, or helping more people move out of their disadvantaged position, for example, through a mix of training/educational reforms and family income supports. Such a strategy takes several years to generate significant benefits, but it ultimately can reduce morbidity and mortality quite significantly and thereby reduces health care costs.

## Next Steps: Refinement, Engagement, and Wayfinding

We will continue to meet with health system scholars to review the game's design so that we may improve its credibility and usefulness. We are also creating an on-line user interface and a group-based instructional design, so that we may extend the opportunity for stakeholders to interact with and learn from the game and from each other.

One of the biggest impediments to past reform initiatives has been that proponents of competing strategies have used different conceptual frameworks, each slanted to support their particular approach. CDC's *HealthBound* game offers a comprehensive and neutral framework in which advocates of different transformation strategies can come together, test their proposals, identify potential shortcomings, and work together to craft a package of interventions that cuts through the current clutter and inertia to reveal a practical way forward.

---

## Note on Accessing the Game and Technical Appendix

You can try the game yourself. Registered members of the Syndemics Prevention Network can access the game at: <http://www2.cdc.gov/syndemics/game.htm>. Select "Play" on the left menu and enter the following access information: user = cdc1@forio.com; password = health.

A Technical Appendix is available at:  
<http://www2.cdc.gov/syndemics/pdfs/game-techappendix.pdf>

To join the Syndemics Prevention Network, go to: <http://apps.nccd.cdc.gov/syndemics/index.asp>

---

## References

Friday Night at the ER (2009), see <http://www.fridaynightattheer.com>

Games for Health (2009) see <http://www.gamesforhealth.org/index3.html>

Hirsch, G. and Immediato, C. S., (1998) "Design of Simulators to Enhance Learning: Examples from a Health Care Microworld", International Conference of the System Dynamics Society, Quebec City, July, 1998 Available at  
<http://systemdynamics.org/conferences/1998/PROCEED/00018.PDF>

Hirsch, G. and Immediato, C. S. (1999) "Microworlds and Generic Structures as Resources for Integrating Care and Improving Health", System Dynamics Review, Fall, 1999

Homer J, Hirsch G, Milstein B. Chronic illness in a complex health economy: the perils and promises of downstream and upstream reforms. System Dynamics Review 2007; 23 (2/3): 313–343

Kemeny, J. and Hirsch, G., (1994) "Mastering the Transition to Capitation", Healthcare Forum Journal, May-June, 1994

Le Claire, R. et al, (2007) “A Prototype Desktop Simulator for Infrastructure Protection: An Application to Decision-Support for Controlling Infectious Disease Outbreaks”, International Conference of the System Dynamics Society, Boston, Ma., July, 2007 Available at <http://systemdynamics.org/conferences/2007/proceed/papers/LECLA417.pdf>

Milstein, B, Homer, J, and Hirsch G., *HealthBound* Technical Appendix. Syndemics Prevention Network, Centers for Disease Control and Prevention. March, 2009.

Strategy wiki (2009), see <http://strategywiki.org/wiki/SimHealth>