

DEVELOPING A SYSTEM DYNAMICS MODEL OF THE UK PRIVATE HOUSE BUILDING

by Séverine Hong-Minh, Paul Childerhouse and Mohamed Naim

Logistics Systems Dynamics Group, Department of Maritime Studies and International Transport, Cardiff University, P.O. Box 907, Cardiff, CF10 3YP Tel: (44) 29 20874271 Fax: (44) 29 20874301 E-mail: HongMinhSM@cardiff.ac.uk

Abstract

The paper describes the construction and the validation of an UK house building system dynamics model. The purpose of the model is to determine the drivers on new private house building demand. Such features as house building starts, construction in progress, housing completion and economic indicators are incorporated in the model.

The focus of the paper is the development of the construction lag sub-system. The development and validation of the model are based on:

- *archival evidence from UK and USA literature,*
- *econometric housing industry models,*
- *governmental data on housing starts, in-progress and completions,*
- *economic data such as the consumer industries indicator,*
- *opinions from industrialists and academics.*

Causal loop, block diagram and difference equation representations of the sub-system model are presented. Statistical analysis of the housing data is undertaken to determine lags/leads in the sub-system and to determine valid causal relationships. The paper evaluates construction lead-times and shows that they lead economic indicators by 5 months. Average lead-times are 17 months although they can vary from 13-20 months. The result concurs with published information that found an average construction lead-time of approximately 16-18 months between 1976 and 1986. Inputting actual starts and comparing the model completions and construction in progress outputs with published data finally validates the construction lag sub-system model. The model fits actual data to within 3%. The validated sub-system model is the first phase in the development of the total house-building model that is of particular interest to UK policy makers and industrialists.

1 INTRODUCTION

The house building industry is increasingly becoming an important research subject in the UK as the need for new, better, customer focused, cost efficient, sustainable houses is increasing. The industry is very challenging as it is highly complex, involving many different parties; regulators, developers, private and social customers and different suppliers and contractors. The mechanisms driving the UK house building market are still in need of research to better understand the industry as a whole and ultimately improve the housing sector.

This paper describes the construction and the validation of a UK house building system dynamics model. This is achieved by a review of existing simulation work carried out in the construction industry. The paper then presents the methodology applied and the construction and validation of the model is presented in detail.

The aim of this paper is to understand the mechanisms specifically underlying the UK private house building industry. The system approach utilised allows understanding of the principal mechanisms of the house building industry although simplicity is given priority. The approach utilised is a combination of systems engineering data analysis techniques for model building combined with traditional system dynamics model representation and simulation.

Even though many house building models have already been studied by researchers, the main mechanisms and element interactions are still not fully understood. This paper adds to the body of knowledge by developing a simple model to represent the house building industry, which highlights the main structural elements involved in the system.

2 LITERATURE REVIEW

Before starting modelling and simulating the UK private house building industry, it is important to look at the work carried out in the same field by other researchers. The field concerned for the literature review is mainly models in the construction industry of which the housing sector is a sub-set. It is essential to first understand previous work that has been undertaken in this field to gain an understanding of the mechanisms of the industry.

2.1 Archival models of the construction industry

Many models have been built for the construction industry. Akintoye and Sommerville (1995) for example study the distributed lag relationships between construction orders and outputs for the UK. Here they consider construction in general including the private and public sector but exclude all repairs and maintenance work. Akintoye and Sommerville (1995) realise that new orders lead to construction output spread over a period of time. Their work focuses on contractor's work and takes into account cash flow considerations. One of their conclusions is that the distributed lags are quite different for the private and public sectors. This is explained by the nature of the sectors themselves and the attitudes of the contractors.

In their model of UK private sector construction demand, Akintoye and Skitmore (1994) consider the following factors that influence construction demand: economic conditions (GNP), construction price (tender price index), real interest rate, unemployment level and profitability. They conclude that private sector housing works in a responsive manner to construction price levels. As for the other factors they only influence private sector commercial and industrial construction demand.

Lee (1999) studies housing cycles and the period of production by focusing on the impact of US housing investment on the supply of new single-family dwelling units. The US housing industry is characterised by long preparation periods and thus the time to adjust the stock to demand is long. Lee (1999) finds that construction time is longer in periods of recessions, which Lee explains by liquidity constraints faced by some firms. However Bils and Kahn (1994) demonstrate that there is a strong negative correlation between construction time and the increase in the number of starts during the preceding year. Furthermore, Tsoukis and Westaway (1994) prove that there is a positive influence of the interest rate on the speed of

completion. Penm and Terrell (1994) also show that the short-term interest rate is influencing the level of housing activity. Lee (1999) also shows clear seasonal variations in construction rates (twice as much in summer than in winter).

Tsoukis and Westaway (1994) forward looking behavioural analysis are based on two different models. The first one is based on Topel and Rosen's (1988) work where adjustment costs are considered as being crucial to house building decisions. Tsoukis and Westaway (1994) emphasis with their model that the cost function of a house building firm exhibits adjustment costs. Their second model is based on Kydland and Prescott's (1982) time to build approach where the focus is placed upon the fact the construction is not instantaneous. Tsoukis and Westaway (1994) prove that future and current house prices are important for house builders to predict the number of houses they need to build. This is based on the assumption that only the house builders can determine the starts (of building houses) and completions (of houses). Finally their third model was not able to prove that apart from price consideration, quantity signals, proxied by the turnover in the housing market, influence starts. This can be justified by Barlow and King (1991) who suggest that house builders do not generally tailor make construction to specific demand.

Tsoukis and Westaway's model is purely an econometric analysis of the UK housing starts based on the price index of new houses and interest rate using seasonal dummies. Some of their results are however interesting, i.e. the construction lag, between start to finish varies between 16 and 18 months for the 1976-86 period against 6 months for the 1972-92 period in the USA (Lee, 1999). This major difference can be explained by the fact that Tsoukis and Westaway are considering all new private construction in the UK, which included blocks of flats and other dwellings being build by very small house builders, whereas Lee only considers single family dwelling units for the US.

Penm and Terrell's (1994) study indicates that housing activity consistently contains leading information, which can be used in forecasting general economic activity. In other words, housing activity is a leading indicator of the general economy. Furthermore, Lee (1999) proves that the housing industry (in the US) invest with two-quarter leads over the general economic conditions. Tse et al.'s (1999) forecasting model for new housing construction in Hong Kong forecast the demand by using the price of properties and show that a rising price is a positive indicator of housing supply.

Meikle and Connaughton (1994) take a look at the stock of dwellings in England and find concerning implications for the life span of houses. At best, housing stock will have to last for up to 250 years, which implies that the amount of maintenance and repair work will have to dramatically increase if the quality of the dwellings is to be maintained. Thus Meikle and Connaughton (1994) suggest that more houses should be built in order to meet the current demand and replace the ailing stock. However Allen and Hinks (1996) critic Meikle and Connaughton conclusions and propose an effective management of multiple-unit housing stock for private housing management companies based on local authorities and housing associations experience. Furthermore, Allen and Hinks emphasis the need for sustainable development instead of disposable development.

3 MODEL CONSTRUCTION

3.1 Methodology

The methodology used for this research is based on the system dynamics modelling and redesign of “real-world” situations proposed by Towill (1993) and is presented in Figure 1.

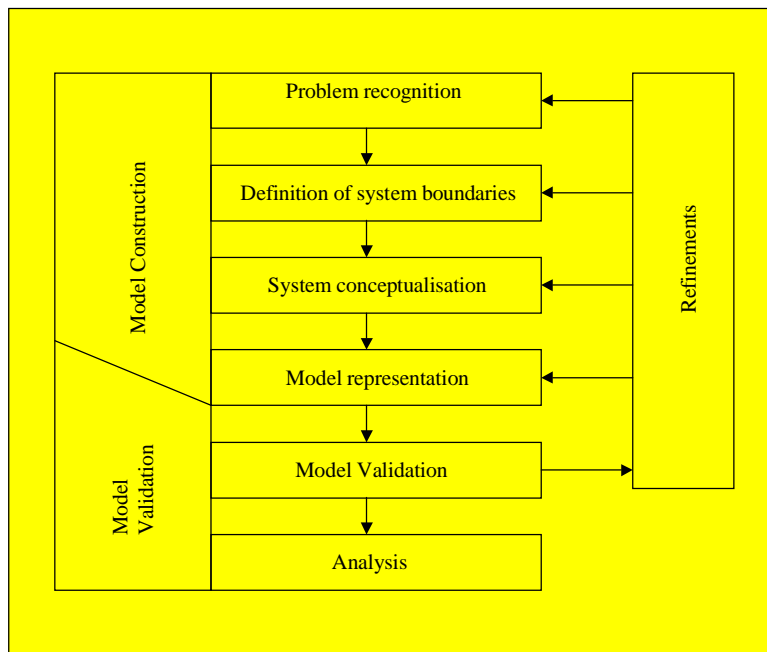

Figure 1: Methodology for system dynamics modelling and redesign of a “real-world” situation (adapted from Towill, 1993)

The following sections will follow the methodology step by step.

The model construction deals with recognising the existence of a problem and representing it in the form of a model that can be simulated. After having recognised the problem, the system boundaries need to be defined in such a way that what is in the system and need to be analysed and what is out of scope can be easily determined. Otherwise, it can be very tempting to include a great amount of unnecessary information. Once the boundaries have been clearly defined, the system can be conceptualised. In other words the relationships between the different elements of the system are represented. Then these relationships can be translated into equations to represent the model.

3.2 Problem recognition

The scope of this paper is to understand the mechanisms of the house building market in the UK and to gain knowledge on the different criteria that influence the number of house completions and the time to build. The first hypothesis investigated is as follows: it is possible to represent construction delay and construction in progress using a system dynamic approach. Furthermore, the model aims at discovering which economical indicator if any are influencing completion rate and/or work in progress (or construction lead-time).

This will be particularly useful for governmental bodies, policy makers and the construction industry itself to understand what influences construction lead-time and actions that are required to obtain sufficient output.

3.3 Definition of system boundaries

It is clearly apparent that the social housing market has extremely different characteristics from the private market as the variables influencing each market are totally different. For example, the number of houses being built for social housing associations are highly dependent on the funding available, whereas for private developers it depends mainly on land availability. Furthermore, most housing associations have a set target in terms of the number of dwellings they can afford to build and maintain, depending on their assets. For all these reasons, the model should only focus on one of these two markets and should not try to aggregate them. As private house building represents approximately 85% of the total number of dwellings built in the UK, it was decided that the model should represent the private house building market.

The model does not aim at being a forecasting model but represents the house building market behaviour as it currently is and was for the past two decades. Finally, the model is not used for housing policy, which is regionally orientated and very specific on site sizes and locations. The model considered in this paper intends to be generic for the UK private house building as a whole, disregarding regional and local trends.

3.4 System conceptualisation

Before simulation can be carried out, it is essential to understand the influence of different components of the UK private house building market. The system considered needs to be conceptualised, by using simple relationships between elements of the system. The model aims at being representative and accurate but also simplified to assist in understanding the model's behaviour. This model is not exhaustive and is under continuous development as the research progresses. The full model can be represented using a causal loop diagram as shown in Figure 2.

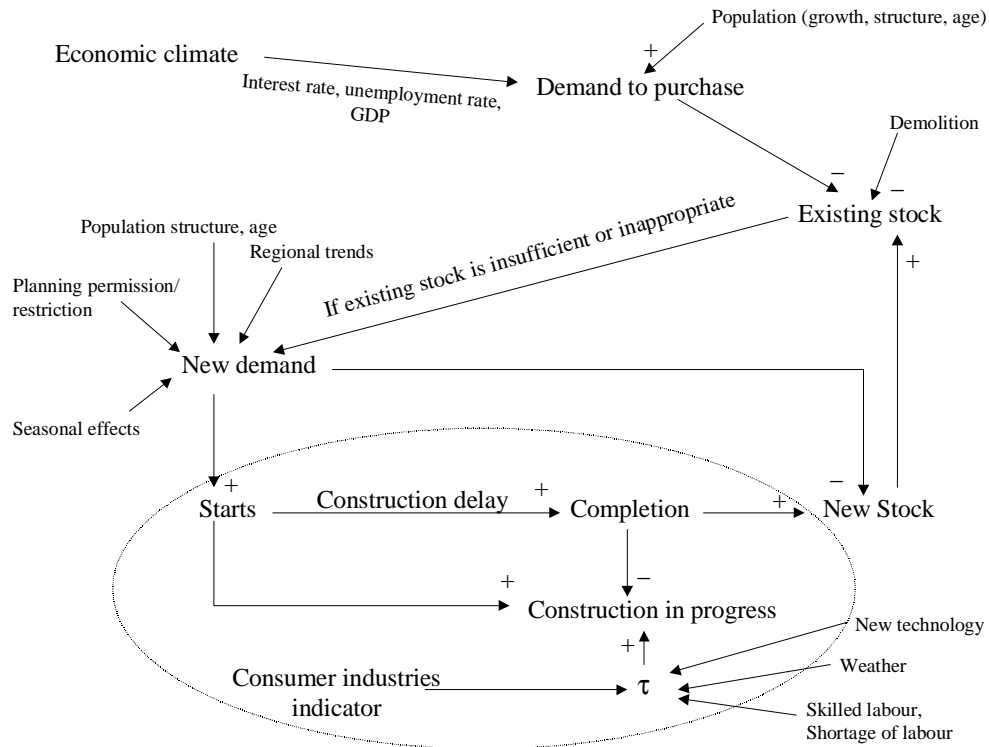

Figure 2: Causal loop diagram of the UK private house building market

For the model, it is assumed that demand to purchase is first fulfilled by the existing stock. If the existing stock is insufficient or inappropriate, then a new demand is created. This time the new demand is for dwellings newly built. As can be seen from Figure 2, a delay is represented between starts and completion and gives way to construction in progress, this relates to Akintoye and Sommerville (1995) and Tsoukis and Westaway (1994) who confirmed with their models that construction is not instantaneous.

For this paper the construction lag sub-system development described is circled in Figure 2. This sub-system will form the first building block of the total system shown in Figure 2 which is the subject of further research.

3.5 Model representation

The causal loop diagram for the construction lag sub-system is represented using a system engineering block diagram shown in Figure 3. The block diagram presented is the final version of the model, its construction and validation are presented in the next sections of this paper.

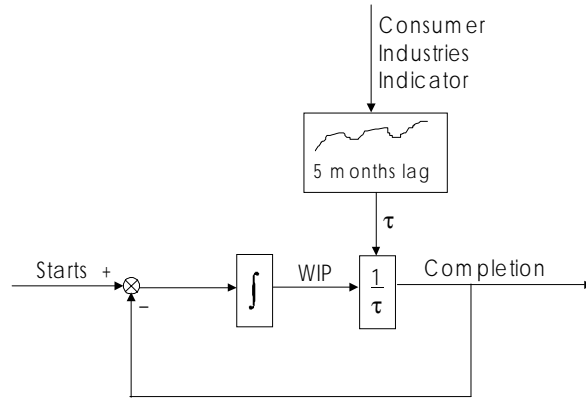

Figure 3: Block diagram of the UK private house building production system

\int is an integrator which converts the Start and Completion rates into a work in progress (WIP) level. τ represents the construction lead-time and is calculated based on the NTC consumer industries indicator as demonstrated later in this paper.

In order to establish the difference equations necessary for the model, historical data was needed. The Housing and Construction Statistics 1987-1997 provided most of the data needed and were completed by the DETR. The data considered were monthly “permanent dwellings started, under construction and completed” in the UK for the private sector for the period 1980-1995.

Based on the block diagram, a set of difference equations can be used to express the final simulation equations for the construction lag sub-system.

Starts

Starts = actual statistical data from the DETR

Completion

$$Completion(t + 1) = \frac{WIP(t)}{\tau(t + 1)} \tag{1}$$

Construction lead-time (τ)

$$\tau(t) = 46.5 - 0.298con(t + 5) \tag{2}$$

Where *con* represents the UK NTC Consumer Industries Indicator

Work In Progress (WIP)

$$WIP(t + 1) = WIP(t) + Starts(t + 1) - Completion(t) \tag{3}$$

Equations (1) and (2) will be justified in the next section of the paper.

4 MODEL VALIDATION

The model validation is concerned with the actual running of the model and the analysis of the results. First of all, the model needs to be tested and parameters set to represent the behaviour required. Next the model results are evaluated against the actual field data. At this point fine-tuning can be done if the model does not represent accurately the data. The validation of the model can then be carried out. Finally the properties of the system can be analysed.

Before running the construction lag model, the causal loop model has been agreed with industrialists and academics as being representative of the current private house building market in the UK.

Systems Dynamics specific software such as DYNAMO and STELLA can be utilised to simulate the UK house building model, however in the present case, Excel 97 was used. The use of a simple spreadsheet shows that dynamics simulations do not need specialised tools to be realised. This is particularly compelling for industrialists and government policy makers who are familiar with simple spreadsheet applications.

To first validate the basic model, it was necessary to calculate τ , Completions and WIP. τ was calculated using equation (4).

$$\tau = \frac{\sum \frac{WIP(t)}{Completion(t)}}{T} \quad \text{where } T \text{ is the number of observations in the time series} \quad (4)$$

Using equation (4), the construction lead-time τ was on average 16.77 months for the period 1980-1995 with a minimum of 13 months and a maximum of 20 months. This agrees with Tsoukis and Westaway (1994) who found an average construction lead-time of approximately 16 to 18 months between 1976 and 1986. This 17-month average construction lead-time has also been confirmed by industrialists and DETR statisticians. Furthermore, the result obtained by calculation was also confirmed using a statistical analysis approach. Time-phased correlation was used for Starts and Completion and the results are presented in Figure 4. The time-phased correlation shows two different peaks where the data is highly correlated, one at a time lag of 6 months, the other at 17 months. Thus from a statistical point of view, both lags would be acceptable, however, as proven by system dynamics, it is apparent that only the 17-month lag is relevant. The peak at 6 months shows that presence of an anomaly and can be explained by the presence of noise, due to aggregation and increase of the historical data, or seasonality or anomalies in the data.

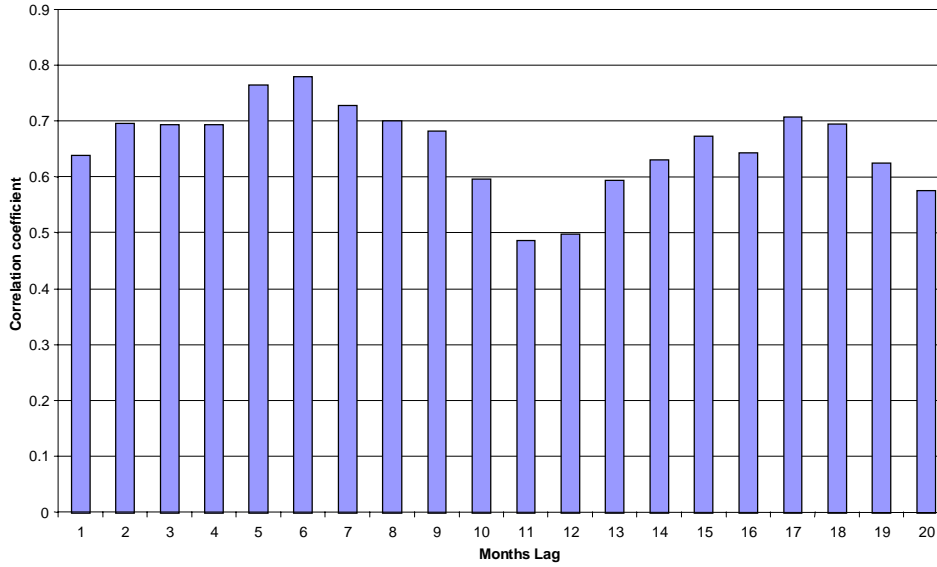

Figure 4: Time-phased correlation between actual Starts and actual Completions

Completions was calculated using equation (1) where $\tau(t+1) = \tau$, WIP using equation (3) and starts has the actual data from the DETR statistics. The validation of the model was carried out using a traditional statistical approach by correlating the model results with the actual data. A sample of the data is presented in Table 1.

Actual WIP	Calculated WIP	Actual Completion	Calculated Completion
195726	199134	11268	11438
198497	201344	10877	11593
201803	205273	12216	11829
204844	208161	11681	12178
209146	212574	12288	12428
215359	219621	13262	12731
219399	222628	11610	13179
221538	224018	12430	13387
224378	226589	13118	13493
225090	228677	14869	13683
224557	230145	15683	13857
220020	225486	13736	13998
217828	222573	13133	13745
217875	222319	13445	13568
219086	223921	13958	13542
221916	224925	11716	13584
235427	227133	12259	13542
228617	230611	13830	13524
231193	233268	13605	13595
231524	233726	13722	13668
230905	233228	13789	13683

Table 1: Sample of data comparing actual and calculated WIP and Completion using τ as an average

The correlation results are as follows:

- Correlation of actual WIP and calculated WIP = 0.938, P-Value = 0.000
- Correlation of actual Completion and calculated Completion = 0.859, P-Value = 0.000

This indicates that the model studied is valid and represents accurately the mechanisms to transform starts into work in progress and then into completions.

4.1 Choice of economical indicator to predict construction lead-time

The next step was to study if τ can be predicted without using the actual data provided by the DETR. The assumption here was that construction lead-time τ is dependent on the general economical climate. Ten economical indicator have been selected and studied and are as follows: retail price index, unemployment rate, NTC consumer industries indicator, economical sentiment indicator, consumer confidence indicator, F.T. actuaries all share price index, retail price index for housing, inflation rate, banks base rate and longer leading indicator.

Two different tools were used to choose the most appropriate economical indicator to predict construction lead-time. The first tool used was multiple correlation using all the economical indicators. The strongest correlation coefficient was registered for the NTC consumer industries indicator with a value of -0.528 and a resultant P-Value of 0.000 . A stepwise regression was then used to determine which economical indicators would predict most accurately the construction lead-time. Here two variables were selected by stepwise: the NTC consumer industries indicator came first with an R-Square value of 27.91 and the banks base rate with an improved R-Square value of 29.49 (the low value for R-Square will be discussed later in this paper). This means that these two variables should be considered to predict τ . However, when considering the correlation between these two variables, it can be seen that the variables suffer from multicollinearity (correlation coefficient of -0.760 , P-Value 0.000). It is important to remember here that when building a prediction model, it is desirable for the variables to be correlated with Y , the value to be predicted. However it is *not* desirable to have the variables to be highly correlated *with each other*. This also means that the second variable, the banks base rate, contributes very little to the prediction of τ , given that the first variable, the NTC consumer industries indicator, is in the model.

It is thus clear that the most appropriate economical indicator to predict construction lead-time is the NTC consumer industries indicator. Using linear regression, the resultant regression equation between τ and the NTC consumer industries indicator is as follows:

$$\tau = 47.1 - 0.305con, \text{ where } con \text{ is the NTC consumer industries indicator} \quad (5)$$

Before being able to use this equation with confidence, it needs to be validated. This has been done using five tests for regression model's assumptions validation. The first test consists of verifying that the residuals have an average of zero. Figures 5 and 6 show that the regression model is valid for the first test.

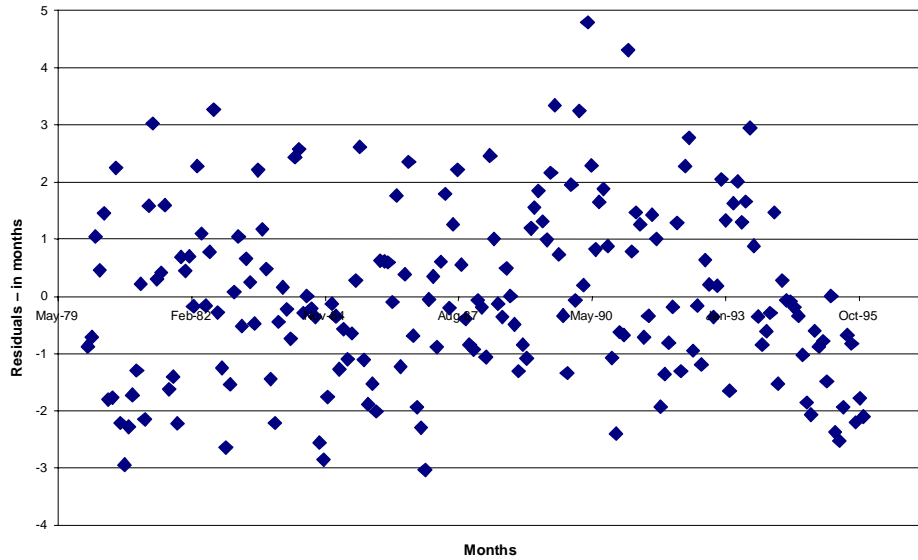

Figure 5: Residuals versus order of data (time) (response is τ)

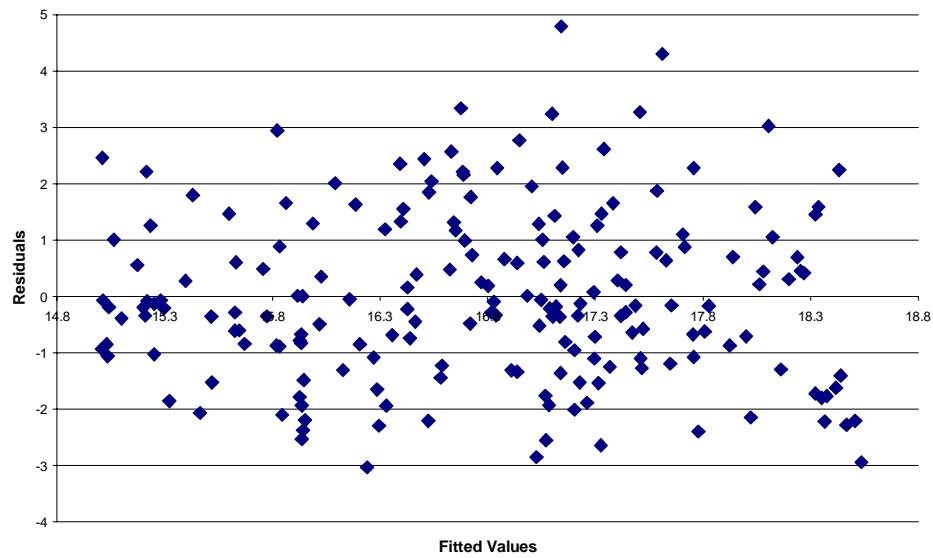

Figure 6: Residuals versus fitted values (response is τ)

The second test assesses if the model suffers from heteroskedasticity, which occurs when the error variance is not constant. Figure 6 shows that the variance of errors is approximately constant and thus the errors are homoskedastic. The third validation of the model is done by verifying that the errors are normally distributed as can be seen from Figure 7.

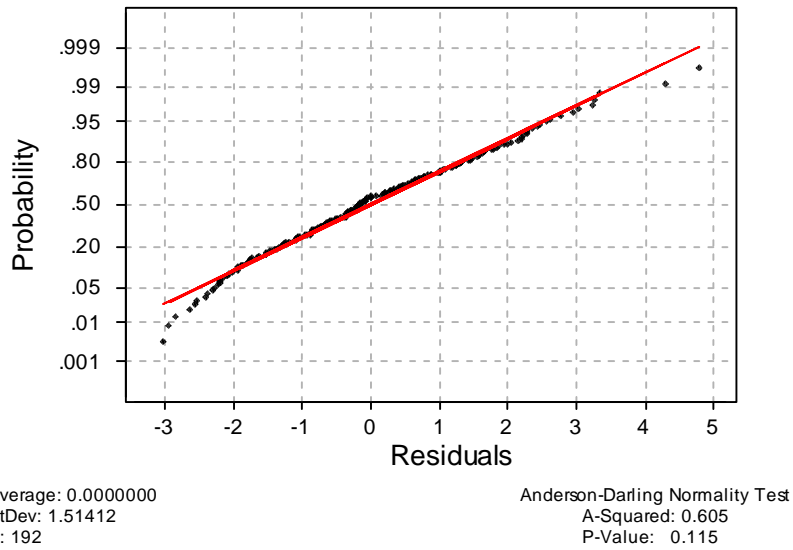

Figure 7: Normal probability plot of the residuals

Figure 5 shows no pattern and thus validates the fourth test, which examines if the errors of the present period are independent from the error of the past period.

Finally the fifth test is ascertained by Figure 8, which illustrates that a linear model is most appropriate.

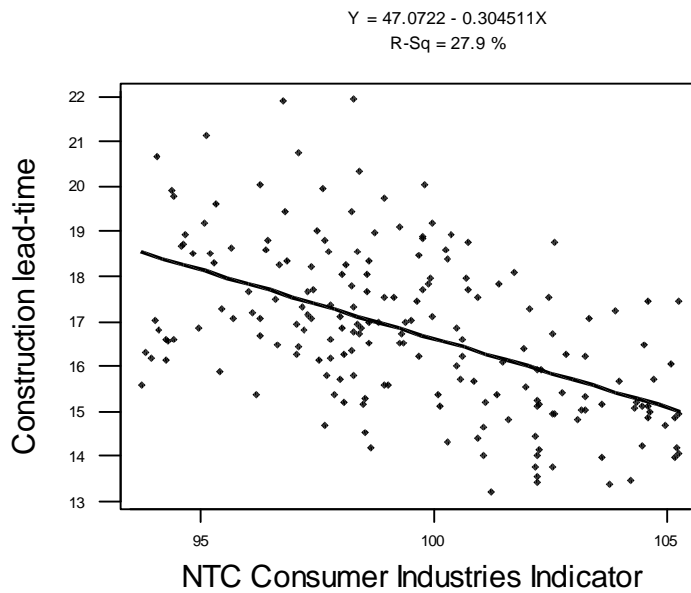

Figure 8: Predictor NTC consumer industries indicator versus Construction lead-time τ

As noticed previously, the R-Square value obtained when predicting τ using con can be considered as being low (27.91). It could be argued that con does not predict τ accurately enough. However, as can be seen from Figure 9, $\tau(con)$, the predicted construction lead-time using the regression equation (5), smoothes actual τ (calculated using equation (6)) and follows its pattern which is desirable for the model. Furthermore the correlation coefficient between τ and $\tau(con)$ is very high with 0.528, P-Value 0.000. It can thus be concluded that it is acceptable to use the regression equation (5) to predict construction lead-time.

$$\tau = \frac{WIP}{Completion} \tag{6}$$

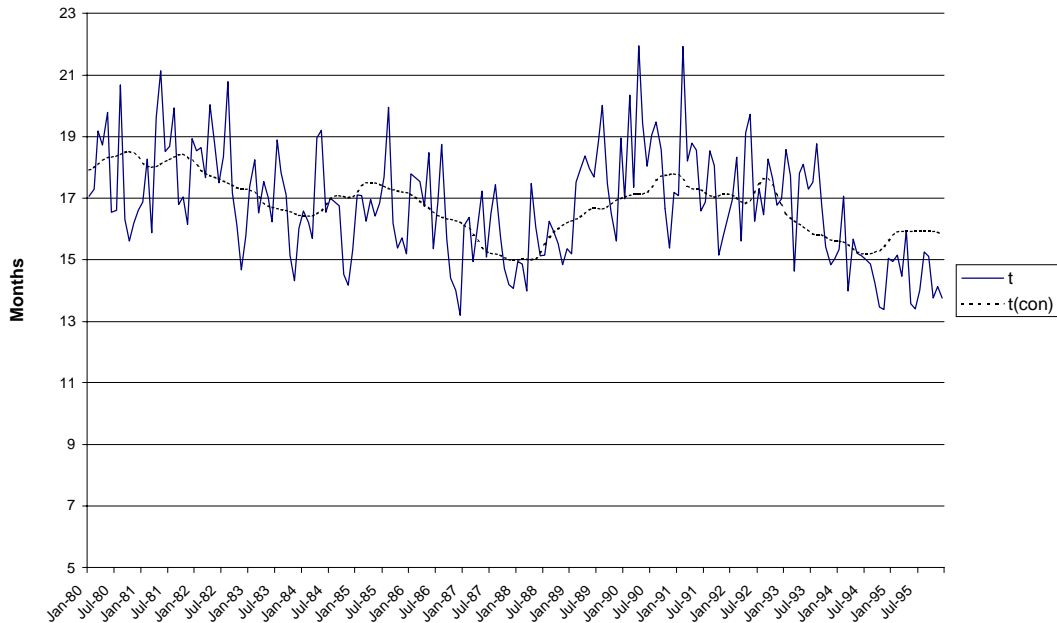

Figure 9: Actual construction lead-time τ and predicted construction lead-time $\tau(con)$ time-series

4.2 Time-phased simulations

Before incorporating $\tau(con)$ in the simulation model, it is important to verify if the time series are not time-phased. The choice of the lag for con has been carried out following several different steps and the results are summarised in Table 2.

The time-series for con has been time-phased up to 5 months negatively ($con(t-5)$) and up to 8 months positively ($con(t+8)$). First of all, the correlation coefficient has been calculated between time-phased $con(t)$ and actual τ . $Con(t-2)$ appears to be the most highly correlated with τ .

All the regression equations, obtained using time-phased $con(t)$ to predict construction delay, have been utilised to calculate the new construction delay $\tau(con(t))$. In other words, for each time-phased $con(t)$ a construction delay $\tau(con(t))$ has been calculated (e.g. $\tau(con(t+3))$) representing the construction delay obtained when using $con(t+3)$). This allows actual τ to be

compared with each individual $\tau(\text{con}(t))$. In this case, the highest correlation coefficient is registered for $\tau(\text{con}(t+4))$.

The next step is to use each $\tau(\text{con}(t))$ in the model to generate new $\text{WIP}(\text{con}(t))$ and $\text{Completion}(\text{con}(t))$. The correlation between actual Completion and $\text{Completion}(\text{con}(t))$ gives the highest correlation coefficient for $\text{Completion}(\text{con}(t+4))$ and $\text{Completion}(\text{con}(t+5))$. It is important to note here that the correlation coefficient obtained between $\text{Completion}(\text{con}(t+5))$ and actual Completion (0.865, P-Value 0.000) is higher than between actual completion and calculated Completion (0.859, P-Value 0.000). The correlation of actual WIP against $\text{WIP}(\text{con}(t))$ indicates the same time-lag with $\text{WIP}(\text{con}(t+4))$ and $\text{WIP}(\text{con}(t+5))$ achieving the highest correlation coefficients. Again, the coefficient (0.973, P-Value 0.000) is higher than for actual WIP and calculated WIP (0.938, P-Value 0.000). This means that using $\tau(\text{con}(t+5))$ to calculate Completion and WIP gives more accurate results than when simply using τ from equation (4).

	Correlation results	Stepwise regression results
Actual τ against $\text{con}(t)$	Con(t-2)	NA
Actual τ against $\tau(\text{con}(t))$	Con(t+4)	NA
Actual Completion against $\text{Completion}(\text{con}(t))$	Con(t+4) Con(t+5)	Con(t+5)
Actual WIP against $\text{WIP}(\text{con}(t))$	Con(t+4) Con(t+5)	Con(t+5)

Table 2: Summary of time-phased simulation results

To help in the decision process for the best-suited time-phased of con , stepwise regression has been used. Here, $\text{WIP}(\text{con}(t+5))$ appears to be the best predictor for actual WIP and $\text{Completion}(\text{con}(t+5))$ for actual completion. Therefore, it appears that $\text{con}(t+5)$ gives the most accurate results for the model simulations. However a cumulative sum of error can also be used to help deciding between $\text{con}(t+4)$ and $\text{con}(t+5)$. These cumulative errors of $\text{WIP}(\text{con}(t+4))$ and $\text{WIP}(\text{con}(t+5))$ have been calculated and are presented in Figure 10.

The cumulative errors indicate if the model is over or underestimating the real data, the angle of the slope shows the magnitude of the errors. From Figure 10, it is possible to identify four different slopes:

- from January 1980 until October 1983,
- from November 1983 until July 1989,
- from August 1989 until December 1993,
- from January 1994 until December 1995.

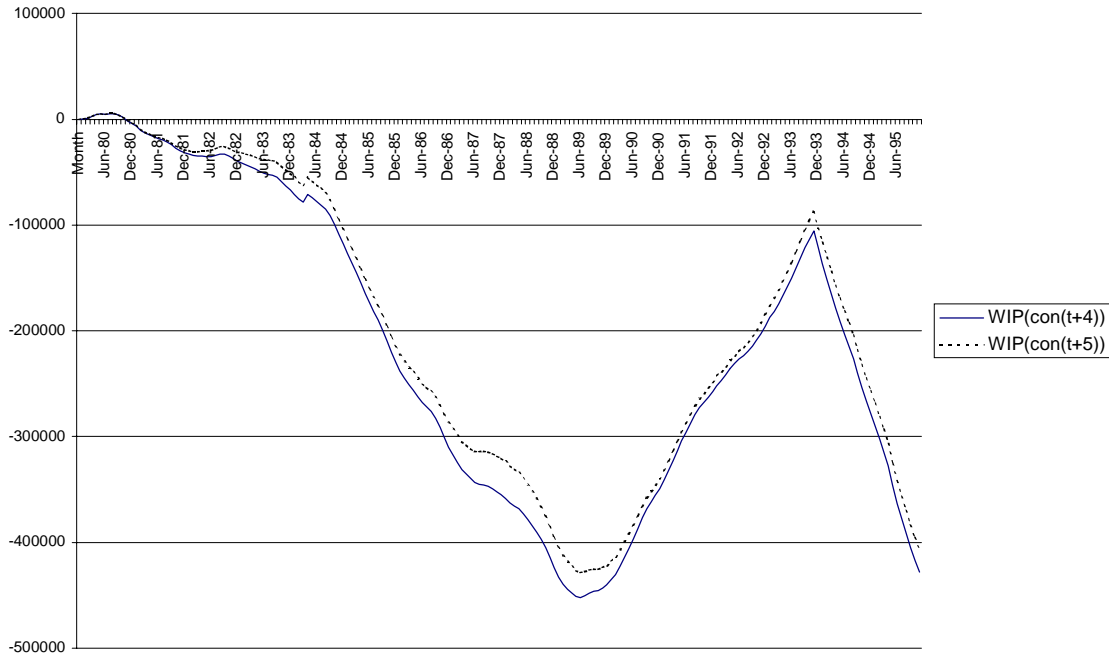

Figure 10: Cumulative errors for WIP(con(t+4)) and WIP(con(t+5))

The results of the cumulative error analysis are presented in Table 3. It appears clearly that there is an anomaly occurring from January 1994 as the model performs as its worst with an overestimate of 5.7%. This can be explained by a change in the counting method utilised by the DETR for the work in progress. The DETR has recently moved to “ground counting” and this can explain the decrease in number of houses under construction. Therefore, if the last period is overlooked, the model fits actual data within 3%. Finally WIP(con(t+5)) always performs better than WIP(con(t+4)) as can be seen from Table 3.

	WIP(con(t+4))	WIP(con(t+5))
Jan. 1980 – Oct. 1983	Overestimate by 0.54%	Overestimate by 0.39%
Nov. 1983 – July 1989	Overestimate by 2.57%	Overestimate by 2.52%
Aug. 1989 – Dec. 1993	Underestimate by 2.94%	Underestimate by 2.90%
Jan. 1994 – Dec. 1995	Overestimate by 5.76%	Overestimate by 5.71%

Therefore, con(t+5) is the most accurate time lag that can be used to calculate τ . This means that the NTC consumer industries indicator (*con*) trends of today will be used to calculate construction lead-time of five months ago. In other words, current τ trends will be exhibited by *con* in five months time. This result is also validated by Penm and Terrell’s (1994) results, which show that the housing industry is a leading indicator for general economic activity.

Furthermore, from the regression equation (2) it can be seen that when the NTC consumer industries indicator increases, the construction lead-time decreases and vice versa. This means

that during booming periods, it takes less time to build houses than during recession periods, this can be explained by the fact that house builders might be facing liquidity problems (Lee, 1999).

5 CONCLUSION

This paper demonstrated that two different approaches can be combined to model, analyse and validate a system: an engineering approach can be used for the modelling and analytical phases while a statistical analysis can be carried out for the validation of the results obtained. Furthermore, the conclusions of the simulations are sustained by various academic references.

The paper showed that it is possible to apply a system dynamics approach to model accurately WIP, Completion and construction lead-time for the UK house building industry. Furthermore, it proved possible to represent the construction delay using a system dynamics approach. The average construction lead-time for the private house building industry for the period 1980-1995 has been proven to be approximately 17 months.

Finally, this paper demonstrated that the construction lead-time can be calculated based on the economical indicator NTC consumer industries indicator and that the model (WIP(con(t+5))) fits actual data to within 3%. Furthermore, this indicator is time-phased; this 5-month lag proves that the house building is a leading indicator. Hence the trends of the construction lead-time of today will be exhibited by the NTC consumer industries indicator in 5 months time. Furthermore during recession periods, construction lead-time increases.

Further research will be carried out to extend the model to include the demand (which is then transformed into starts) and stock. We are particularly interested to understand the dynamics resulting from the model and its effects on downstream players within the supply chain. There is also the potential to adapt the model into a forecasting model that could be used to predict the amount of WIP and completions. Different demand forecasting models that are already available (e.g. the Chelmer model) could also be used to forecast the demand and thus forecast the production rate of houses in the UK.

6 ACKNOWLEDGEMENTS

This paper highlights work undertaken during an EPSRC IMI and DETR funded research project as part of a LINK programme on Meeting Customer Needs through Standardisation. The sponsorship and the time and effort made available by the industrial partners is gratefully acknowledged. Thanks also to Prof. David Gann, Dr. James Barlow and Dr. Ritsuko Ozaki of Sussex University who are the academic partners on the research project.

7 REFERENCES

- Akintoye, A. and Sommerville, J. (1995). Distributed lag relationships between UK construction orders and outputs. *Construction Management and Economics* 13(1), 33-42

- Akintoye, A. and Skitmore, M. (1994). Models of UK private sector quarterly construction demand. *Construction Management and Economics* 12(1), 3-13
- Allen, S. and Hinks, J. (1996). How long should housing last? Some implications of the age and probable life of housing in England. *Construction Management and Economics* 14(6), 531-535
- Barlow, J. and King, A. (1991). The state, the market and competitive strategy: the housebuilding industry in Britain, France and Sweden. Paper presented at the *International Conference on the Economics of Housing Markets*, LSB, London, September.
- Bils, M. and Kahn, J.A. (1994). The cyclical behavior of inventories and time-to-build in the new housing market. *Working paper, University of Rochester*
- Kydland, F.E. and Prescott, E.C. (1982). Time to build and aggregate fluctuations. *Econometrica* 50(6), 1345-1370
- Lee, G.S. (1999). Housing cycles and the period of production. *Applied Economics* 31(10), 1219-1230
- Meikle, J.L. and Connaughton, J.N. (1994). How long should housing last? Some implications of the age and probable life of housing in England. *Construction Management and Economics* 12(4), 315-321
- Penm, J.H. and Terrell, R.D. (1994). Is housing activity a leading indicator? *The Economic Record* 70(210), 241-252
- Topel, R. and Rosen, S. (1988). Housing investment in the United States. *Journal of Political Economy* 96(4), 718-740
- Towill, D.R. (1993). System dynamics – background, methodology and applications. Part 1: Background and Methodology. *Computing & Control Engineering Journal* 4(5), 201-208
- Tse, R.Y.C., Ho, C.W. and Ganesan, S. (1999). Matching housing supply and demand: an empirical study of Hong Kong's market. *Construction Management and Economics* 17(5), 625-633
- Tsoukis, C. and Westaway, P. (1994). A forward looking model of housing construction in the UK. *Economic Modelling* 11(2), 266-279