

Newton Paulo Bueno<sup>1</sup>  
Federal University of Viçosa  
Department of Economics  
Minas Gerais, Brazil  
npbueno@ufv.br

## 1 - Introduction

Unlike the common point of view, there is a lot of consensus about practical issues among the macroeconomists today<sup>2</sup>. We can sum up this core of practical macroeconomics that (almost) all they believe as to be the following : i ) in the long run , the trend movement is predominantly driven by the supply side of the economy, that is by the supply of factors of production and total factor productivity; ii) in the short run, movements in economic activity are dominated by movements in aggregate demand, and these movements are contained within a moderately narrow range; iii) the movements along the long run trend are not due to monetary policy shocks, but to nonpolicy shocks such as technology ones; iv) due to these shocks, there is, in theory, a space for stabilization policies; v) even Keynesians do not exhibit more than a lukewarm enthusiasm for countercyclical fiscal policy, therefore the practical stabilization policy debate has been centered on monetary policy; vi) there has been a critical change in practical macroeconomics methodology which was the switch to consider stabilization policy as a game-theoretic problem, rather than a control theory problem<sup>3</sup>.

This paper will not dissent from this consensus. Our objective here is just to suggest that despite of the general validity of propositions above, the methodology change referred in topic vi) is not entirely justified, because the game-theoretic approach is not capable of explaining certain movements in economic variables which have been observed during the last years. One of the most important has been the resurgence of inventory cycles in the US economy, which standard practical macroeconomics has considered not an important factor in explaining business cycles since the early 1990s, due to the widespread adoption of new inventory control practices. However, there is no enough evidence to support this view. In the 1990-1991 recession, for instance, declining inventory investment contributed 59% to the drop in the US real GDP, similar to the postwar average; in the subsequent expansion inventory investment came to account for 31% of GDP growth.<sup>4</sup>

Inventory cycles are a typical system dynamical pattern which seems to require explanation based on the control theory approach, abandoned in the modern debate about stabilization policy. In two papers written in the 1950s, the eminent English economist A. W. Phillips, using control theory approach, suggested that the economy could exhibit

---

<sup>1</sup> Research funding granted by the Brazilian National Council of Scientific and Technological Development (CNPq) should be gratefully acknowledged

<sup>2</sup> See, for a summary of this consensus, Solow (1997), Eichenbaum (1997) and Blanchard (1997).

<sup>3</sup> For a representative paper see Alesina and Drazen (1991).

<sup>4</sup> Filardo (1995).

fluctuations along its historical growth trend in response to stabilization policy (or, by the way, to any another shocks) only because there were time delays involved in the industry supply lines<sup>5</sup>. In doing that he provided the theoretical explanation behind subsequent empirical analysis of the destabilizing effects of fine tuning<sup>6</sup>. But, in these papers, Phillips did not exactly make clear why that happened. The objective of this work, starting from the Phillips' two classical papers, is to offer a system dynamics based explanation for aggregated investment instability generated by problems of supply line management.

Specifically, we intend to show that this kind of instability is similar to that which makes difficult managing supply line in famous Beer Game developed by the system dynamics group of MIT Sloan School of Management<sup>7</sup>. It will be pointed out that ignoring production time delays causes instability not because economic agents simply ignore supply line delays, but because they adjust their expectations more rapidly than the delays involved in supply lines, whatever those delays could be.

The paper is structured in three sections. In the first we present the Phillips' argument in modern dynamic system language, in order to show how to build a simplified macroeconomic supply line model for investment dynamics; in the second section, the macroeconomic model is developed and simulated. Third section concludes the paper suggesting that the inclusion of production time delays in macroeconomic models reopens the space to the control theory in stabilization policy debate.

## 2 – The Phillips' stabilization model

The basic model in diagrammatic form, presented in the two Phillips' classical papers, is showed in Figure 1.

---

<sup>5</sup> Phillips ( 1954, 1957).

<sup>6</sup> Leeson (1998).

<sup>7</sup> Sterman ( 1989)

FIGURE 1 : THE BASIC PHILLIPS MODEL IN DIAGRAMMATIC FORM

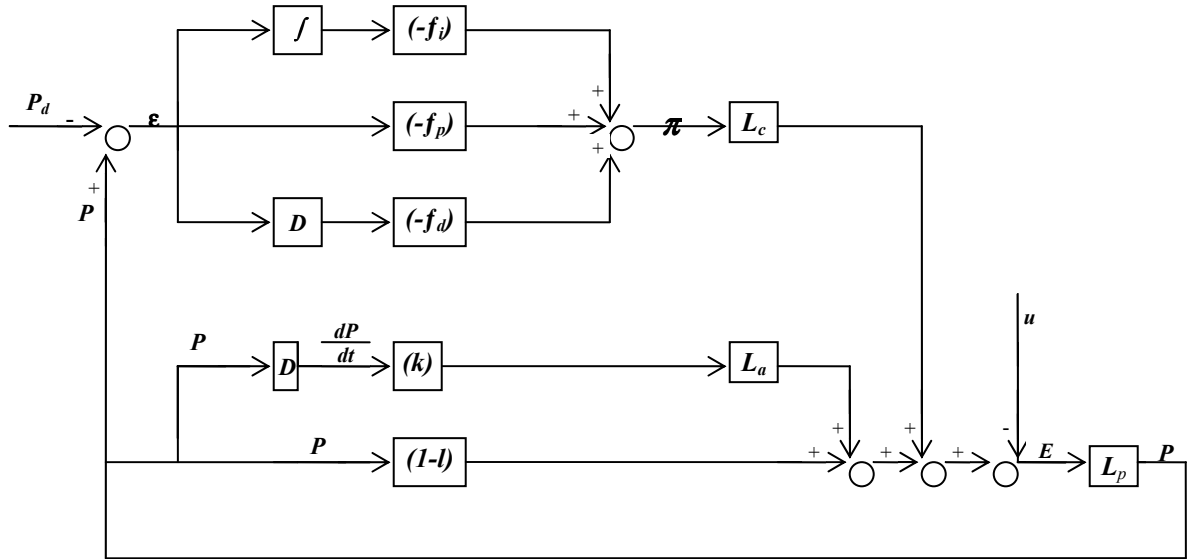

The lines in the diagram represent the variables of the system, measured as deviations from initial equilibrium values. Relationships between variables are indicated inside the squares, and the signal (+) represents a direct relationship between them. It is assumed, in the lower closed loop at the bottom of the diagram, that aggregate real production,  $P$ , responds to changes in aggregate real demand,  $E$ , through the lag relationship  $L_p$ ; two different forms of the production lag  $L_p$  were considered: single exponential lag in 1954 paper and triple sequential exponential lag in the paper of 1957. Changes in aggregate real demand are analysed into three components.  $E_y$  represents those changes in demand which are related to changes in income through the multiplier ( $1 - l$  is the marginal propensity to spend).  $E_\pi$  is the policy demand, i.e., it is the amount by which aggregate demand is increased or decreased as a direct result of action taken by government for the purpose of stabilizing the economy. Changes in aggregate demand caused by changes in factors other than income and stabilization policy are included in the variable  $\mu$ .

The actual level of production,  $P$ , is subtracted from the desired level of production giving the error in production  $\epsilon$ . The basic problem in stabilizing production is to relate the actual policy demand to the error in production in order to correct those errors as quickly and as smoothly as possible. In order to obtain satisfactory regulation it is usually necessary for the potential policy to be made by the sum of three components: one depending on the error itself, one depending on the time integral of the error and the third depending on the time derivative of the error. That is, the relationship should be on the form:

$$\pi = f_p \epsilon + f_i \int \epsilon dt + f_d \frac{d\epsilon}{dt}$$

Where  $f_p$ ,  $f_i$ , and  $f_d$  are parameters denoting respectively the proportional, integral and derivative correction factors.

The basic model, including the effect of proportional and integral stabilization policies only, can be represented in system dynamics language by the model represented in figure 2.

To show the effect of such policies we suppose there occurs at time zero and continues thereafter a fall in demand of four units (including the exogenous fall of one unit in the demand plus the multiplier effect related). That fall will make the indicated order decrease reducing production rate through the supply line, which is modeled as:

$$\text{Supply Line} = \text{INTEGRAL} (\text{Order Rate} - \text{Production Rate}, 0)$$

And

Production Rate = DELAY1(Indicated Orders, Delay Time Lag), for the single delay model

or

Production Rate = DELAY3(Indicated Orders, Delay Time Lag), for the triple delay model

And

$$\text{Delay Time Lag} = 0.5$$

FIGURE 2: THE BASIC PHILLIPS MODEL IN SYSTEM DYNAMICS LANGUAGE

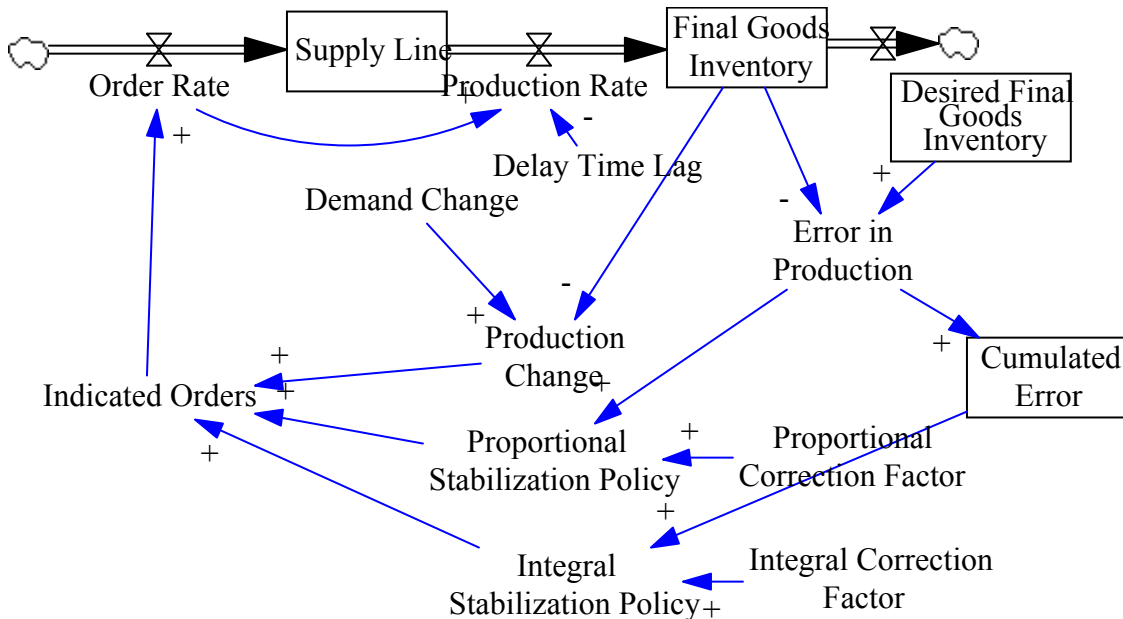

The decrease in the Final Goods Inventory causes positive production change and a discrepancy in relation to the Desired Final Goods Inventory, which the Government will try to correct by stabilization policies increasing Indicated Orders. A proportional stabilization policy is one in which the correcting action taken is such that the policy demand is made proportional in magnitude and opposite in sign to the error in production. An integral stabilization policy is one in which the correcting action is made proportional in magnitude and opposite in sign to the cumulated error up to that time. That is:

$$\text{Proportional Stabilization Policy} = \text{Error in Production} * \text{Proportional Correction factor}$$

$$\text{Integral Stabilization Policy} = \text{Cumulated Error in Production} * \text{Integral Correction factor}$$

The effects of the policies are showed in figure 3. Note that in single exponential lag model (the 1954 model) the larger the correction factors the most effective are stabilization policies. The opposite is true in the triple exponential lag model. Indeed for high values of correction factors, such as  $f_p$  and  $f_i = 8$ , the system becomes explosive.

FIGURE 3: SIMULATION RESULTS

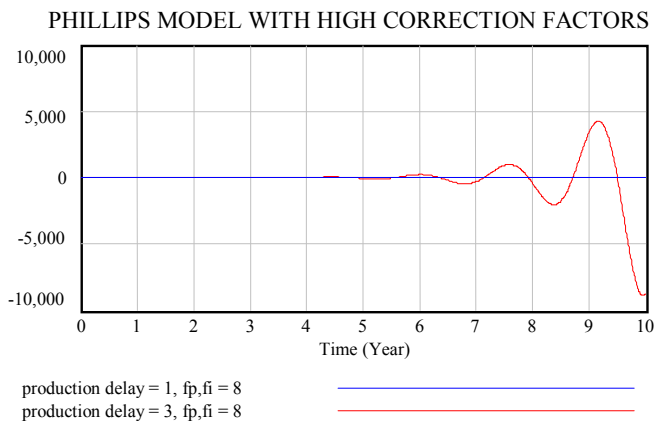
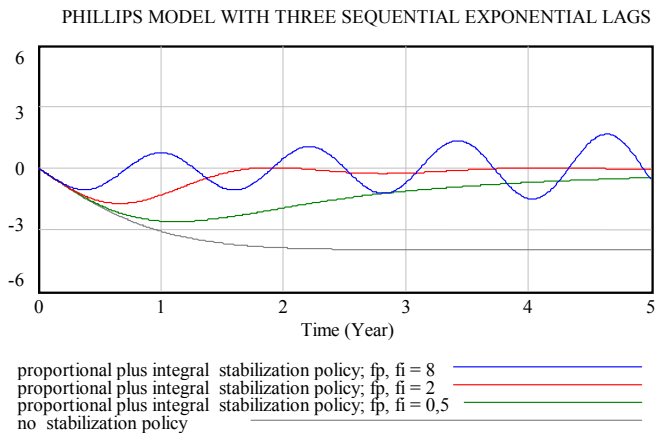
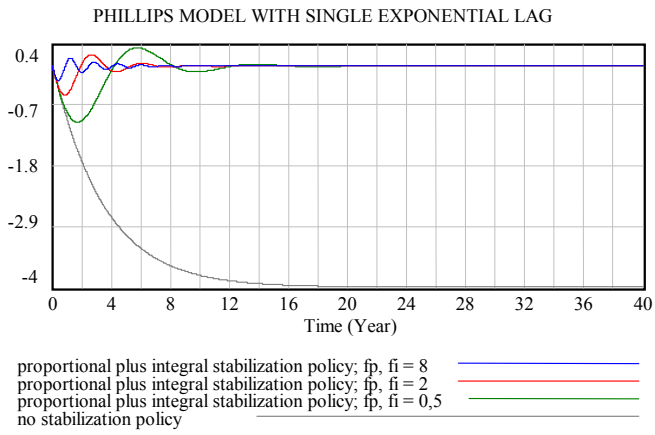

The conclusion is that the main source of instability in stabilization policy is what Phillips calls the time delays operating in his model, that is, the form of the production delay<sup>8</sup>. In his own words<sup>9</sup>:

“...the regulation of a system can be improved if the lengths of the time delay operating around the main control loop are reduced. The distinction between delays and lags should be noticed. What is of primary importance is that the correction action should be adjusted continuously and with the minimum possible delay to changes in the error and that adjustment should quickly produce some initial effect. It does not matter very much if it takes a long time for the policy change to have their full effect. In fact, it can be shown that if there is a long delay before corrective action is taken or before it begins to have an appreciable effect, it is better that the effect, when it does come, should be gradual rather than sudden. The worst possible condition for regulating purposes is one in which the adjustment of policy demand to a change in the error is delayed for a considerable time and then effected quickly and abruptly.”

It is not clear, however, why exactly this happens in Phillips’ papers. In the next section, because the main source of instability in the latter Phillip’s model is the same that makes so difficult managing supply line in the Beer Game, we built a similar macroeconomic model of stabilization policy which helps to clarify this point.

### 3 – The Beer Game and stabilization policy: a simple macroeconomic model

In the beer game, as in all unstable supply line models, oscillation requires both that there be time delays in the negative feedbacks regulating the state of the system and that the decision makers fail to account for these delays – ignoring the corrective actions that have been initiated but have not yet had their effect. Experience has demonstrated that there are a number of reasons for ignoring delays, in fact it is doubtful that persons, even the more sophisticated ones, can always do it. But our point in this paper is not exactly that.

The point is that ignoring delays causes instability not because economic agents simply ignore supply line delays, but because they adjust their expectations more rapidly than delays involved in supply lines, whatever those delays be. Even if they do not know precisely the supply lines delays, if they adjust expectations about future sales slowly, oscillations either would not surge or would be damped. But, and this is very important, for a certain expectation formation pattern, changes in supply line delays can generate huge oscillations on Investment and therefore on the National Income. The macroeconomic model showed in figure 4 outlines this feature of the dynamic supply line models.

---

<sup>8</sup> The distinction between time delays and lags is that the former refers to the interval during which there is no response at all and the latter is the period in which a continuous gradual adjustment takes place.

<sup>9</sup> Phillips (1957: 276)

FIGURE 4: A SIMPLE SUPPLY LINE MACROECONOMIC MODEL

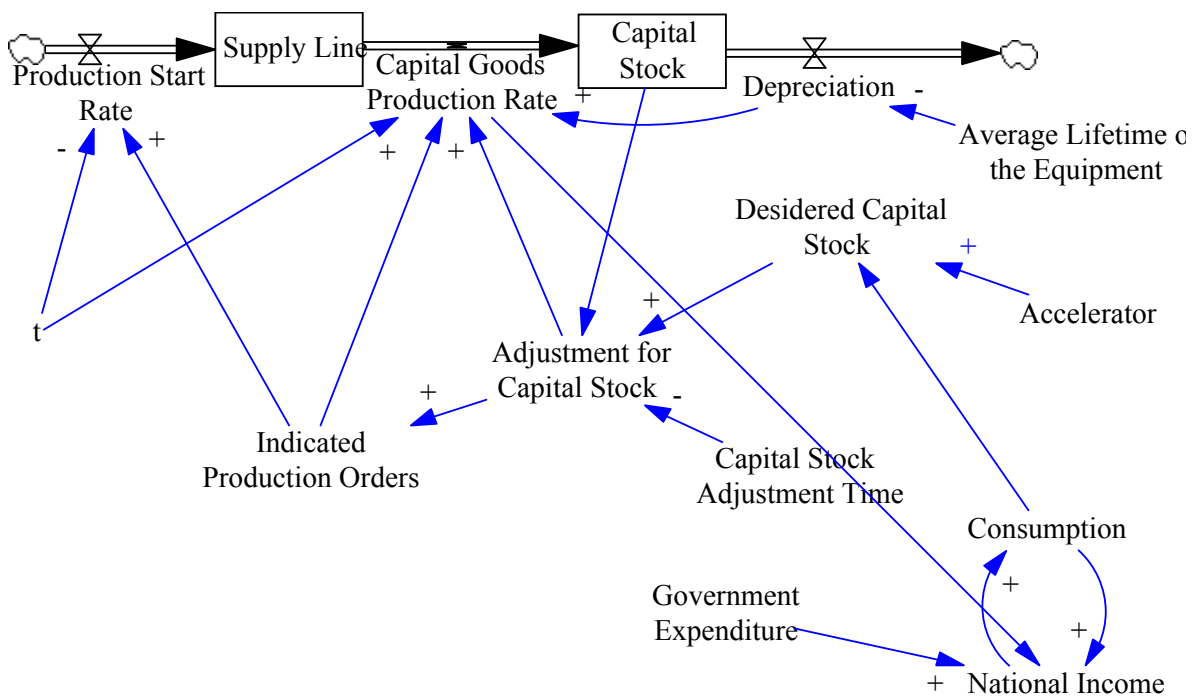

Capital Goods Production Rate corresponds to Gross Investment and is modeled as follows:

$$\text{Capital Goods Production Rate} = \text{DELAY1} (\text{Production Start Rate, Delay Time Lag}) + [1/(1+t) * \text{Indicated Orders}].$$

or

$$\text{Capital Goods Production Rate} = \text{DELAY3} (\text{Production Start Rate, Delay Time Lag}) + [1/(1+t) * \text{Indicated Orders}].$$

and

$$\text{Production Start Rate} = t/(1+t) * \text{Indicated Production Orders}$$

That means that part of Capital Goods can be acquired in the spot market but the remaining must be ordered to capital goods industry, entering in the supply line of this industry. Note that, if  $t$  is, for instance, 2, 67% of new capital goods must pass through the supply line of capital goods industry, which is modeled as follow .



Supply Line = INTEGRAL (Production Start Rate – Capital Goods Production Rate, 0)

Adjustment for Capital Stock is related to Consumption by a simple multiplier/accelerator relation:

Adjustment for Capital Stock = (Capital Stock – Desired Capital Stock) / Capital Stock Adjustment Time

Desired Capital Stock = Consumption \* Accelerator<sup>10</sup>

Accelerator = 1.7

Simulations presented in Figure 6 represent the effect of \$1 increase in government expenses in year 10 returning to the original level thereafter. A number of important features of the models are outlined. First, when investment expectations are adjusted fast, capital good production becomes highly unstable even for low values of the supply line time delay. The graphic on the top of Figure 6 assumes a first order time delay in the capital goods industry supply line and a Capital Stock Adjustment Time (CAT) of 1. The second graphic, on the other hand, shows that increasing CAT, that is making expectation adjustment slower, improves stability properties of the model. The graphic at the bottom, finally, indicates that delay time lag length is not very important to explain the time path of the adjustment. That is, the important thing, as already stated by Phillips in his classical papers, is that corrective action (as stabilization fiscal policy) begins so quickly as possible and not that the correction time (measured by the length of the delay time lag) itself is short.

It is easy to see therefore that the source of model instability is the fact that investment plans and capital goods production plans are adjusted at a different pace. This suggests that instability can increase if production approaches the potential product of the economy, because production delay times tend to become larger. So, in principle, perhaps it is possible to identify a proxy to capacity occupation level in some volatility index of capital goods production, but doing this would exceed the limits of this work.

---

<sup>10</sup> As variables are measured in terms of deviations from equilibrium values we can formulate the acceleration relation in this way .

FIGURE 6: CAPITAL GOODS PRODUCTION RATE

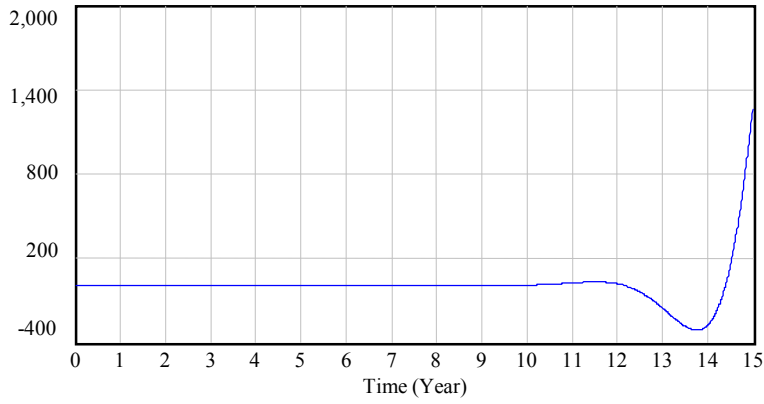

Time delay =1; CAT = 1

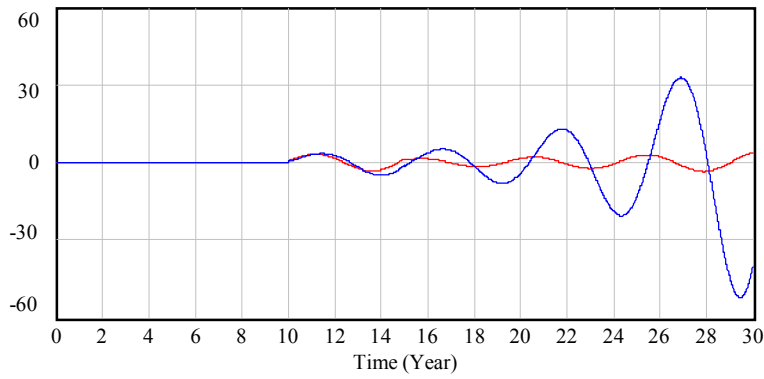

Time delay =3; CAT = 1,5  
Time delay =1; CAT = 1,5

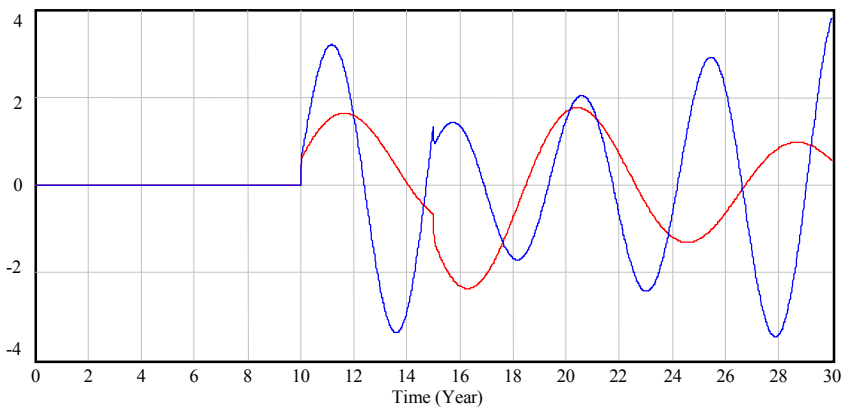

Time delay =1; CAT = 1,5; Delay Time Lag = 0,5  
Time delay =1; CAT = 1,5; Delay Time Lag = 1,5



## 4 – Conclusions

Because of the simplified nature of the models in this paper the results that have been obtained cannot be applied directly to the interpretation of actual economic situations. A few elementary conclusions can, however, be drawn with some confidence.

The first one is that delays in capital goods industry supply line cannot be ignored in the formulation of stabilization policy. Macroeconometric models, however, have neglected this fact, paying attention only to other factors such as expectation formation, the role of nonpolicy shocks, as technology shocks, and stickiness level of prices and wages. The conclusion of this work is not that these factors are not important, but that their contribution for economic dynamics can be better evaluated if we consider the existence of time delays in the production of capital goods. The main reason is that, whatever the way expectations are treated, longer time delays in supply lines will increase the instability of the economy's response to stabilization policies. Likewise in the MIT Beer Game, this happens because people adjust expectations more rapidly than firms can adjust their production plans.

The second elementary conclusion is that, as inflationary stabilization policies tend to be implemented when the economy grows above its potential production level, it is probable that they can produce instability rather than stability in stocks, investments and, therefore, in the production level of the economy. This is because the higher the capacity occupation level of the economy the longer time production delays. It also seems probable, for the same reason, that we could identify in future works a proxy to the capacity occupation level in some volatility index of capital goods production.

The last conclusion is that the switch in practical macroeconomics methodology to thinking about stabilization policy as a game-theoretic problem, rather than a control theory problem, might be premature. It seems plausible that we should assume a more balanced view, in which the control theory methodology, but in modern system dynamics language, shall have again an important role in the debate.

## References

- ALESINA, A. and A. DRAZEN (1991) Why are stabilization delayed? *American Economic Review*, vol. 81 (5)
- EICHENBAUM, M. (1997) Some thoughts on practical stabilization policy. *American Economic Review*, vol. 87 (2)
- FILLARDO, A. (1995) Recent evidence on the muted inventory cycle. *Economic Review – Federal Reserve Bank of Kansas City*, vol. 80 (2).
- PHILLIPS, A.W. (1957) Stabilization policy and the time-forms of lagged responses. *Economic Journal*, vol. 67, June.
- \_\_\_\_\_ (1954) Stabilization policy in a closed economy. *Economic Journal*, vol. 64, June.
- SOLOW, R. (1997) Is there a core of usable macroeconomics we should all believe in? *American Economic Review*, vol. 87 (2)
- STERMAN, J. (1989) Modeling managerial behavior: misperceptions of feedback in a dynamic decision making experiment. *Management Science* 35(3).
- LEESON, R (1998) The ghosts I called I can't get rid of now: the Keynes-Timbergen-Friedman-Phillips critique of Keynesian macroeconometrics. *History of Political Economy*, 30 (1), spring.

## Abstract

In the last years there has been a critical change in practical macroeconomics methodology which was the switch to thinking about stabilization policy as a game-theoretic problem, rather than a control theory problem. Our objective is to suggest that this methodology change is not entirely justified, because the game-theoretic approach is not capable of explaining certain movements in economic variables, as inventory cycles, which have been observed in the last years. In two papers written in the 1950s, the eminent English economist A. W. Phillips, using a typical modern system dynamics language, suggested that the economy could exhibit such fluctuations in response to stabilization policy only because there were time delays involved in the industry supply lines. But, in these papers, Phillips did not exactly make clear why that happened. The objective of this work, starting from the Phillips' two classical papers, is to offer an explanation for aggregated investment instability generated by problems of supply line management based on system dynamics approach. It is concluded that it seems plausible that the control theory methodology shall have again an important role in the debate on stabilization policy. The system dynamics methodology seems to be specially fitted to put this theory in a more modern language.