

## **A System Dynamics Approach to the Structure and the Economy of Fur Farming and Trade**

by

**Pål I. Davidsen,**  
Associate Professor,  
Department of Information Science,  
University of Bergen,  
Norway.

**Leif Jarle Asheim,**  
Senior Research Associate,  
Norwegian Agriculture Economics  
Research Institute, Oslo,  
Norway.

### **Abstract**

The purpose of this paper is to explain the expansion and the contraction of the Norwegian mink supply in an expanding market, as a consequence of the mink pelt price and the mink farming costs. Significant variations in price, and time lags between capacity adjustments, breeding decisions, and the fur sales, makes fur farming speculative, and only a small fraction of the farmers generate their main income from such farming.

Moreover we estimate, using a Bayesian approach, the farmers loan fraction, their response to profitability, and a few delays in economic perception and capacity adjustments. This model is the first one in a series under development, portraying the national and the international fur production and market. In addition to reflecting the Norwegian mink production, this model may be considered generic for international fur production. An international demand model is under development.

Finally, empirical evidence indicate the relevance of our model to the current development in the Danish mink farming and to the Norwegian fox farming.

### **1. Studies in the economy of fur farming**

Except for accounting, planning and budgetary guidelines for farmers, virtually nothing has been written on the economy of fur farming. The international database "World Agriculture Economics and Rural Sociology Abstracts" (CAB) contains no references to this subject. On the regular Nordic seminars on fur production, no such studies have been presented. They only concern improvements in production techniques, such as genetics, feeding, and veterinary practices.

The Danish textbook on mink farming (Dansk Pelsdyravlforening 1984) and the Norwegian textbook in fur farming (Norges Pelsdyrslag 1969) only briefly address economic issues, such as investment and profit calculation at current prices. The economy of fur farming in Norway has also been examined on individual mink and fox pilot farm basis. The accounts results are varying extensively, depending upon the efficiency of the farms and the prices achieved.

A few nationally oriented studies have been undertaken. In Sweden, a survey was made regarding the farming profitability among 24 farms for the years 1965 - 66 and 1967 - 68 (Fagerlind 1969). Because of the limitations and bias of the material, one may draw no conclusions relevant to our model from this survey. One Finnish study, by Koskenranta-Kouki (Koskenranta-Kouki 1982) concluded that fur farming (mainly fox) in the seventies, although characterized by strong price fluctuations, has generally been a low profit industry, yielding an average 7.1 % return on investments. Especially during the years 1970 and 1974 the farmers were living from a minimum yield. One of the most important later findings of Koskenranta-Kouki (Koskenranta-Kouki 1986), is the correspondance between fluctuations in OECD GNP and fur prices over the period 1964 - 84. Her conclusion is that the general economic development

significantly influences fur prices. Additionally there are occasional factors like changes in fashion, weather, and rates of exchange. In our current work, we are investigating these relationships as a basis for a demand model.

**2. The dynamics of the Norwegian fur farming**

Estimates of pelt production in Norway dates back to around 1926. We have used data for the period 1960 up until recently. This period has been characterized by the farming of various breeds of mink (dark, brown, blue, white and others). So far, we have restricted our analysis to mink farming, although fox has become an important supplementary or competing commodity. Figure 1 shows the development of the number of breeding minks and foxes over this period. Figure 2 shows the corresponding development of pelt prices.

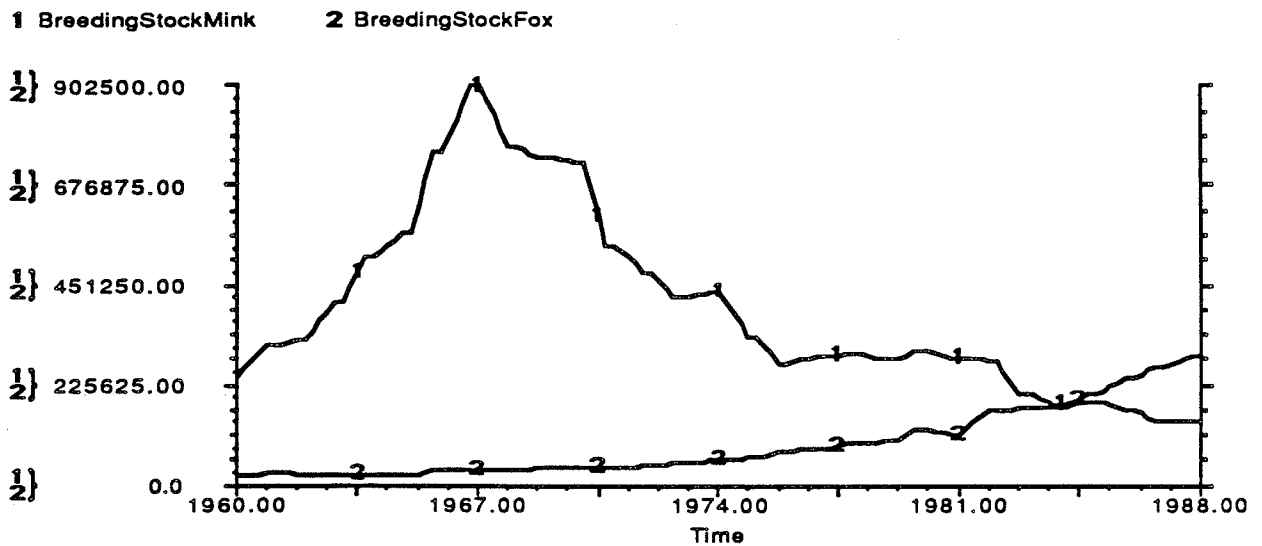

Figure 1: The breeding stocks of Norwegian minks and foxes.

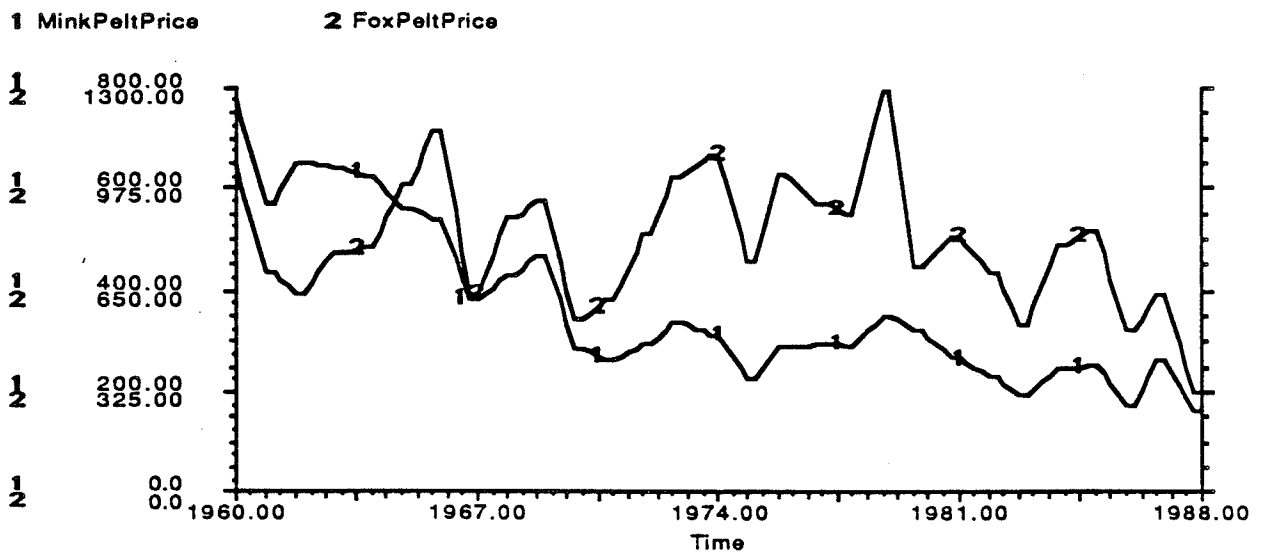

Figure 2: The pelt prices of Norwegian mink and fox (weighed average of blue and silver) (1987 NOK).

In the 1950's, Norwegian farmers were used to fairly stable, high mink pelt prices - yielding an income per hour more than 5 times the average farming income. Financially supported by private and governmental banks, they took advantage of this opportunity and expanded rapidly. The expansion was not biologically restricted, but limited by capital and capital equipment. A fair amount of the investments were provided by the farmers themselves, utilizing spare time between harvestings and products from their own forests. The rapid expansion caused the breeding stock to increase by a factor of 5 within 7 years. Simultaneously, the pelt prices fell dramatically. But it was not until 1967, that production peaked. At that time, prices had fallen to a level that would sustain an equilibrium supply corresponding to the original 1/5 of the peak.

As a result of this capital over-expansion, a contraction set in, almost just as dramatic as the expansion. Within 10 years, the breeding stock fell back to the 1960 level. But by then, prices had declined even further, farming was barely profitable, and the breeding stock has, since then, been gradually reduced. No significant capital equipment investments were made after 1967. Today the breeding stock is less than 1/6 of the 1967 level. Note that the mink market itself has expanded during this contraction. E.g. in Denmark there has been an exponential growth in the breeding stock during the 1980's.

For comparison reasons, note that fox pelts are around 3 times the size of the mink pelts, that foxes require 3.5 - 4 as large cages, and 2.1 - 3 times as much feed. During the seventies, we experienced a steep increase in blue fox farming, and in the eighties a similar increase in silver fox production, both corresponding to an increase in pelts price. Recently there has been a stagnation and a slight decline in total fox production. Although prices have been dropping as well, fox farming has been more economically important than mink since 1978.

### 3. A feedback structure of mink farming

A feedback loop diagram of the model is shown in figure 3 on the following page. There are three small regulating (negative) feedback loops: The breeding stock is regulated by pelt production, originating from age related replacement. The production capacity is regulated by capacity adjustments, and the long term liabilities are regulated by fixed cost payments. The production capacity is restricted financially by available (disposable) loans. Two negative feedback loops regulate the production capacity, and thus the production, within the financial boundaries: restricting a capacity expansion through a fixed and a variable cost increase. Then there are two negative feedback loops that regulate the breeding stock: Given the pelt price and the fixed costs, the profit per pelt, is determined by the variable costs, running according to the size of the breeding stock. Lower profits from a larger breeding stock reduces the desired breeding stock and thus the recruitment, and vice versa. Moreover, there is a delay in closing the gap between the profit determined breeding stock and the actual one. So the desired breeding stock is restricted by the current one which thus affects the recruitment. Finally, there is a negative loop that interrelate the production capacity and the breeding stock: An increased production capacity creates fixed costs which reduces profitability, the desired and, eventually, the actual breeding stock. This erodes the working capital and restricts a further capacity expansion.

There are three major positive feedback loops that counteract the regulating loops and drives the model through the expansion, followed by the contraction. First of all there is the small, fundamental biological condition for breeding stock growth and decline, through recruitment. Then there is the major loop connecting production capacity and breeding stock: Increased production capacity lifts the breeding stock goal. This facilitates a larger breeding stock, which generates more profits, creates more disposable loans, and allows for expansion of production capacity. By its capital generating gain, this loop has the power to create expansion and to reinforce a contraction. Finally, a capacity expansion increases fixed costs which reduces the profit. This leads to a lower desired breeding stock and lower variable

capital requirements, leaving more working capital for expansion purposes. Contrary to the former one, this positive loop works within, but does not change the financial conditions of the farming.

Note that the pelt price is exogenous to our model, i.e. it does not enter any feedback loop. During expansion, the price has a dual function in the model: On the one hand, a rising price creates an incentive to increase the breeding stock. On the other hand, it facilitates an expansion by increasing the total assets. During contraction, both incentives and possibilities are gradually eroded.

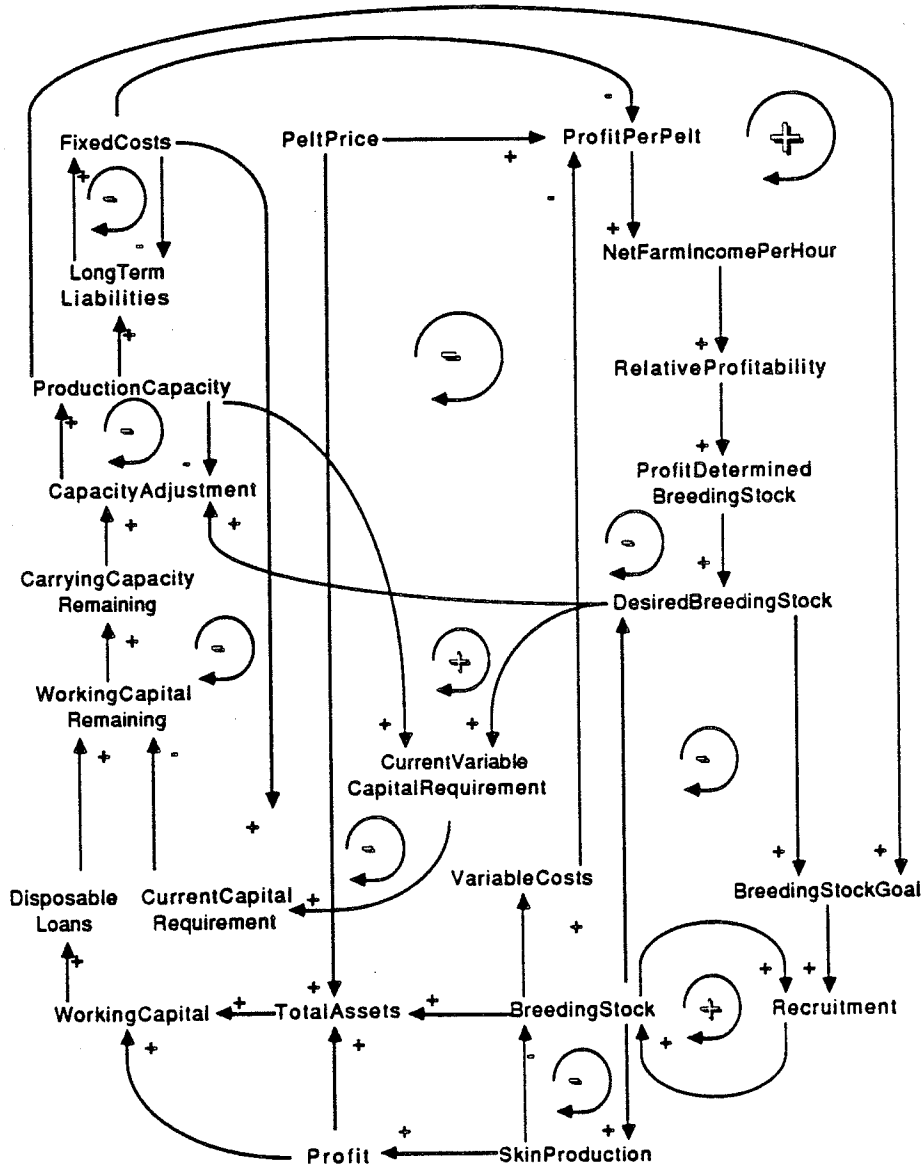

Figure 3: The feedback loop structure of the mink fur farming

4. A discussion of the simulation results

The model described, was implemented and simulated using Professional DYNAMO™ and STELLA™. Generally, the model is based upon reliable structural information with a few uncertain parameters,

utilized for tuning purposes. Due to the specific historic development, it is possible to estimate four such parameters:

During the up-turn, capital investments, determined by the farmers' willingness and ability to invest, dominated the model trajectory. So, for the period 1960 - 67, tuning was done primarily with respect to the loan share and to the planning, financing, acquisition, and construction delay. The first of these parameters determines the force with which the expansion takes place; the second one the distribution of the capacity response to the available capital. The loan share was estimated to 45 % and the time to adjust capacity to 2.4 years, both considered reasonable by experts.

During the down-turn, the time to perceive profitability and to adjust the breeding stock, and the willingness to do so, are dominating. The delays determine the timing of responses to changes in relative profitability. As the breeding stock fluctuates significantly with profits, the total delay is distinct. The major uncertainty remaining, is the magnitude of the farmers response to a change in the profitability with respect to the breeding stock, i.e. the relationship between the relative profitability and the associated breeding stock. This relationship was portrayed by a table function and estimated blindly. I.e. the person performing the estimation was not aware of the point of reference on the x-axis where the relative profitability is 1. The net mink farm income was averaged exponentially with a 2.3 years delay (closely corresponding to the delay in capital equipment adjustments). This income was compared to the income of alternative forms of farming, averaged over 3 years.

The blindly estimated response to profitability, portrayed in figure 4, indicates that some farmers farm minks even under a state of low average profits, either as a supplementary source of income or with competitive efficiency. When the relative profitability increases from 0.5 to 1.5, the indicated breeding stock increases significantly. From then on, a second, more profit-oriented set of farmers seem to enter: In the relative profit range 1.5 - 4, the indicated breeding stock increases exponentially, and saturates over the range 4 - 6.

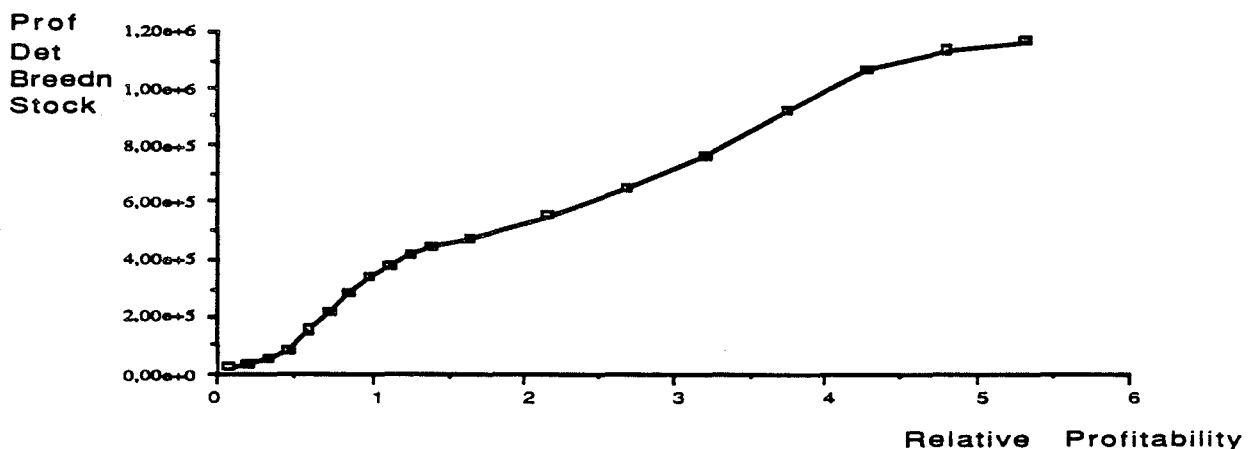

Figure 4: The breeding stock indicated by the relative profitability.

Figure 5 and 6 exhibit the results of the simulations. Both the simulated breeding stock and the sales of pelts (slightly smoothed to represent buffering inventories) coincide with historic records. As for the sales overshoot, in the late 1960's, one must assume that the fertility was reduced at that time to reinforce contraction. As for the lack of correspondance over the last couple of years, notice that this is caused by the model's response to significant fluctuations in the profitability of alternative forms of farming, not by absolute changes in the conditions of mink farming.

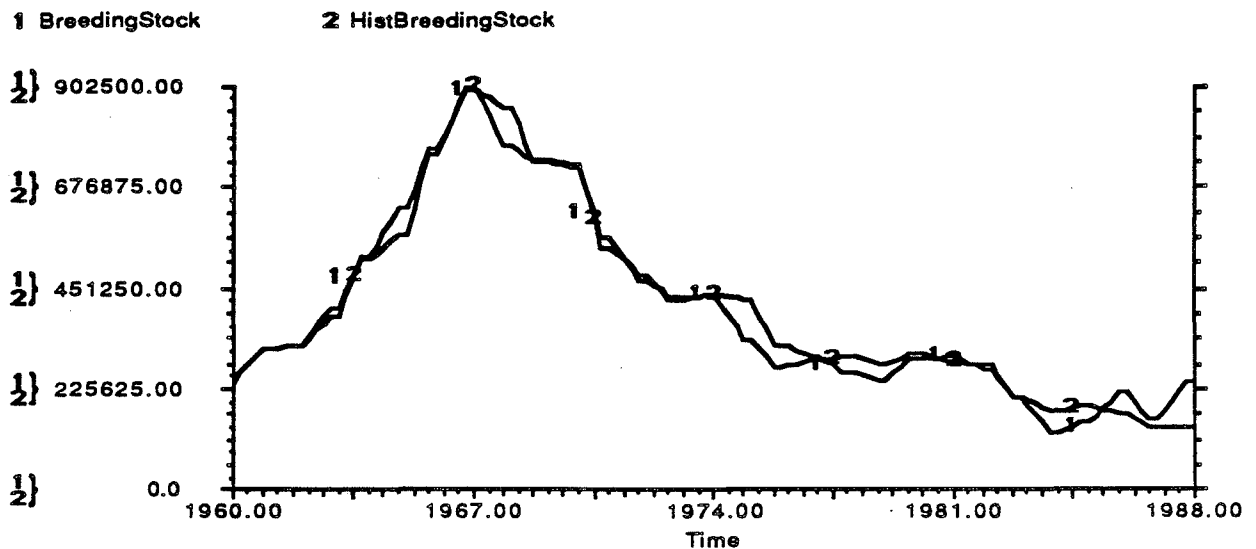

Figure 5: The simulated and the historic breeding stock.

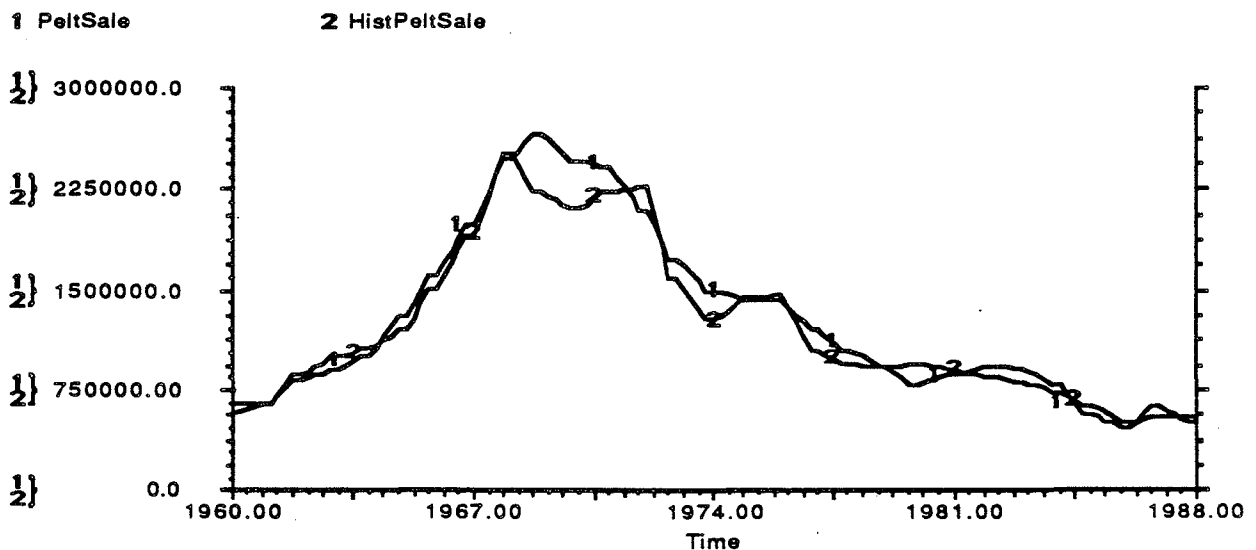

Figure 6: The simulated and historic pelt sales.

Given prices and costs, our model replicates well the development of the mink breeding stock and the production of mink pelts in Norway. During the expansion phase, the model has been used to estimate the loan fraction and the delays in the capacity adjustment process. During the contraction phase, the model has been used to estimate the relationship between the profitability of the mink farming, relative to alternative forms of farming, and the corresponding, indicated breeding stock. The contraction also facilitated estimation of the delays in perceiving changes in profitability and in adjusting to the indicated breeding stock (without further investments).

The model may be used as a basis for a supply-side submodel representing the international fur market. Coupled with a demand model, and given the general economic growth in OECD, we expect our model to generate prices endogenously.

## 5. Conclusions

Norwegian mink farming was internationally important during the 1960'ies and its effect may be clearly identified in development of the international supply, shown in figure 7. Mink farming has not been subject to increased efficiency so as to meet international competition, typically from Denmark which has contributed to the exponential expansion in the 1980'ies. Such improvements arise from scientifically conducted animal husbandry, yielding increased fertility, and resulting in lower consumption of feed, and improved access to inexpensive feed. There may be three major reasons why Norwegian farmers have lost competitiveness:

1. Higher feeding costs (than competitors) due to the competitive fish farming industry utilizing the same kind of feeding, and to high costs of transportation, and a low level of farm industrialization, husbandry and marketing.
2. Alternative sources of income, such as petroleum and fish farming industry, and a willingness among Norwegian farmers to change occupation;
3. Bankrupcies leading to poor investment incentives.

As a consequence, our model does not contain the technological development sector, triggered under tight economic conditions, which is relevant when modeling the international production.

Facing the Danish expansion, similar to the previous one in Norway, in a market characterized by falling prices, indicated that our model should be tuned and applied to the Danish mink farming as well. By naïve prediction, the Danes should by now have over-expanded, and be in for a recession. Moreover, we have already experienced a similar pattern of behavior in fox farming with falling prices following breeding stock expansions, resulting in a later contraction. In this market, however, Norway is not as dominating as it was, and as Denmark is, in the mink market. It must be expected that our model could be tuned and applied for the fox markets as well.

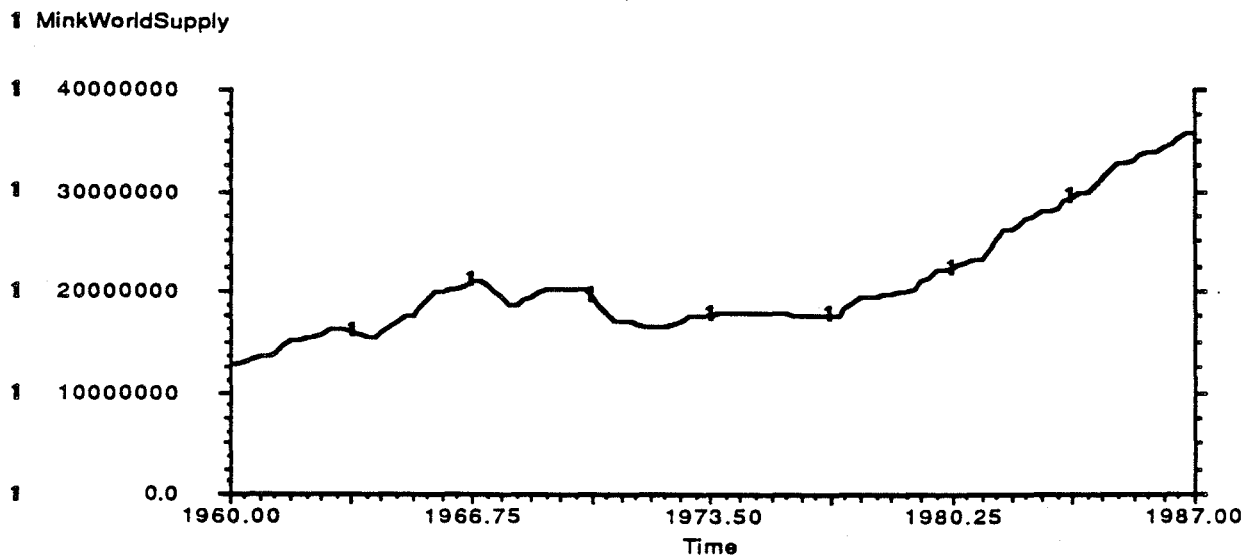

Figure 7: World mink pelt supply to open markets

## 6. Further work

Several countries, Eastern European in particular, only auction a fraction of their production on open markets, primarily when prices are high, to generate foreign currencies. Therefore a production model is not sufficient to determine supply, which may also be heavily influenced by price. In addition, inventories of unsold pelts must be included in the model.

At the moment we are working with a model that represents the international mink demand. One problem is that the historic world demand and inventories are not known. We only have information on the supply. From the fluctuating prices, we may conclude, however, that there must be a significant correlation between OECD GDP and the mink demand.

Having developed a demand model, the supply and the demand model will be synthesized to obtain an international fur market model. As indicated, our model would probably be a useful characterization of the current Danish mink farming and the Norwegian fox farming.

## Appendix A: Model Documentation

This appendix contains a documentation of the model portrayed in figures 8 and 9 on the following two pages.

### 1. Breeding Stock, Recruitment and Ageing.

#### 1.1 Breeding Stock

BreedingStock = BreedingStock + dt \* ( Recruitment - BrdStockPeltProduct)

The breeding stock consists of a mixture of female and male minks at a ratio of 20:4. The breeding stock is increased by recruitment and decreased by slaughtering, yielding pelt production from the breeding stock.

The Central Bureau of Statistics has determined the exact historic size of the breeding stock, plotted in figure 1 by counting during the Summer 1959, 1969, and 1979 (Statistisk Sentralbyrå 1961, 1971, and 1982). For the periods 1959 - 69 and 1969 - 79, yearly estimates of the number of minks are available from The Budget Committee for Agriculture (Budsjettnemda for jordbruket 1989). These numbers have been weighed to fit the years from which we have exact numbers. Since 1978 yearly estimates have been made on the basis of governmental support statistics (Budsjettnemda for jordbruket 1989). The Central Bureau of Statistics also publish data for production of fur pelts from farm raised minks and foxes on the basis of information from The Norwegian Fur-Breeding Association (Statistisk Sentralbyrå 1989). For these numbers, there are no exact reference countings.

#### 1.2 Recruitment

Recruitment = MIN (WhelpProduction \* 0.5 \* (1 + (4 / 20)),  
MAX (0, (AgeRelatReplacement + (BreednStockGoal - BreedingStock))))

The recruitment is limited by the production of female whelps. Half of the whelps are female. In addition, male whelps must be recruited at the ratio 4/20. Moreover, the recruitment cannot be negative (see Pelt Production). Except for these two limitations, recruitment is constituted by age related replacements and the adjustment of the breeding stock, i.e. the difference between the desired and the actual breeding stock.



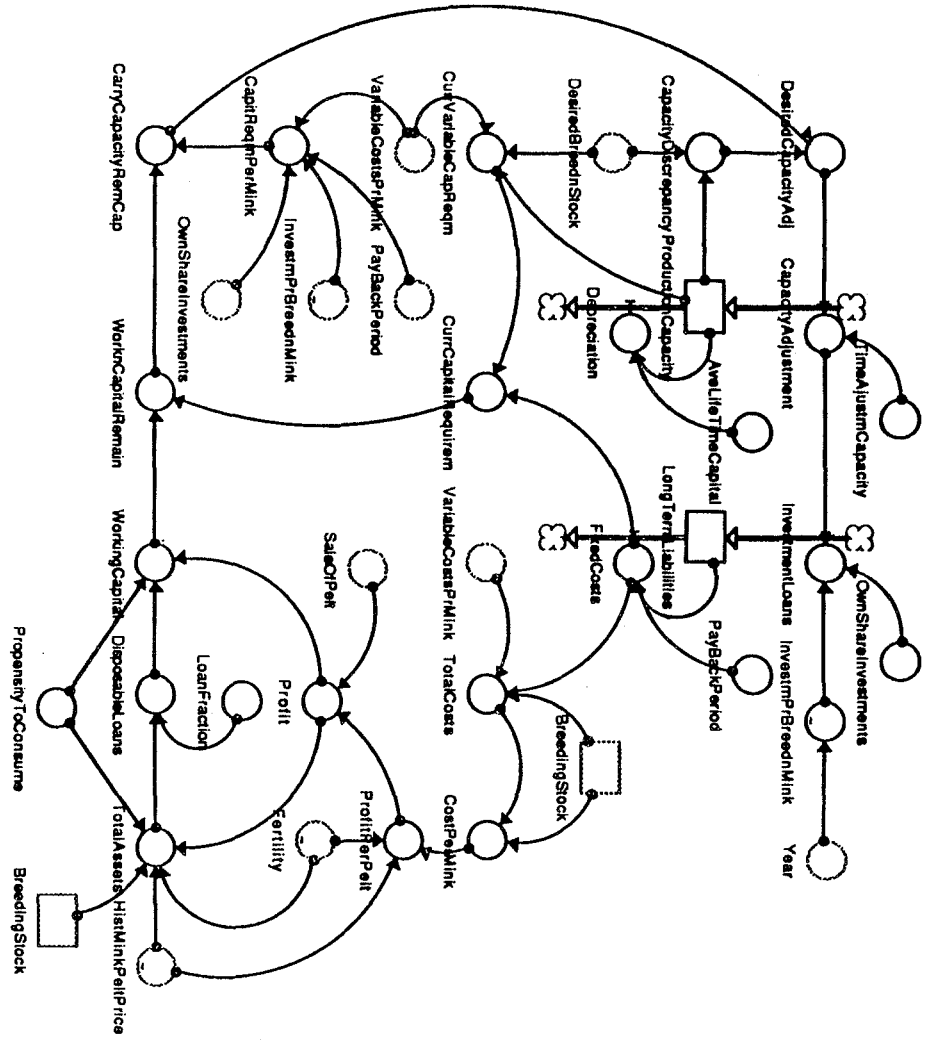
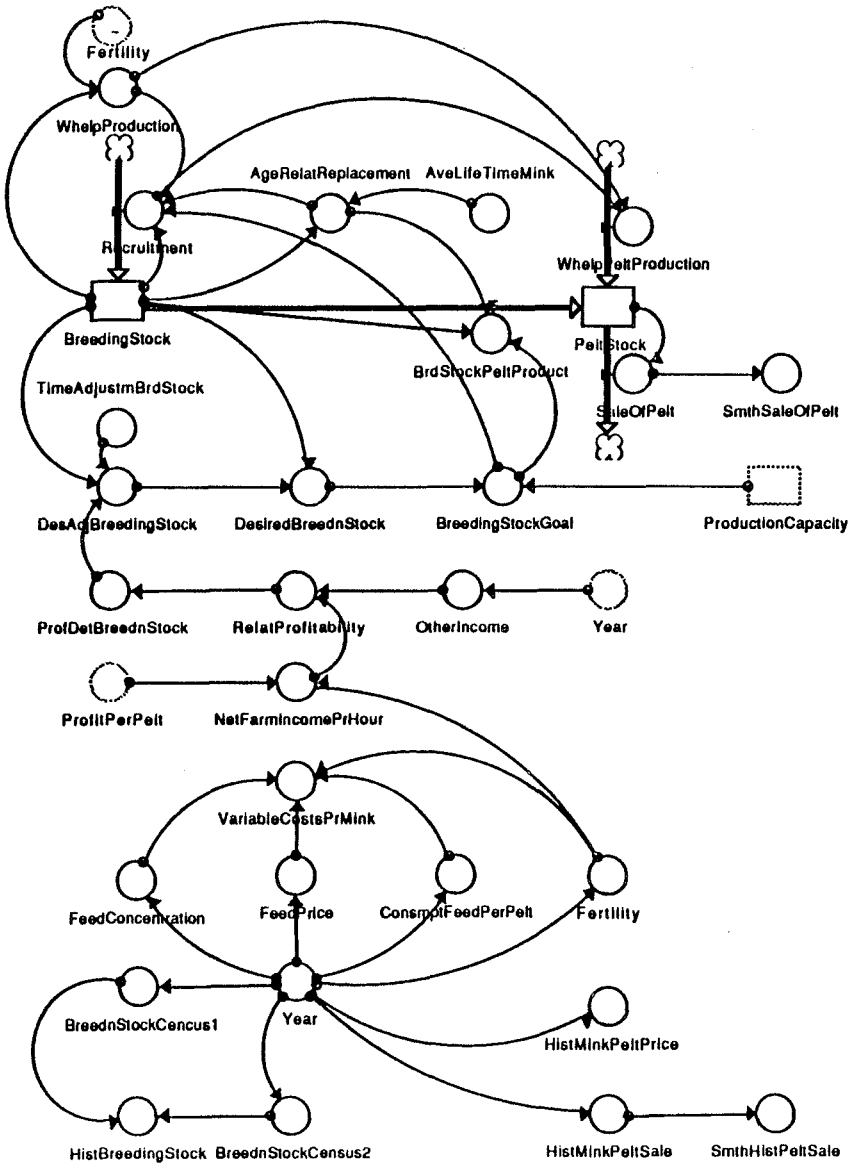

### 1.3 Whelp Production and AgeRelated Replacement

$$\text{WhelpProduction} = \text{BreedingStock} * (1 - (4 / 20)) * \text{Fertility}$$

$$\text{AgeRelatReplacement} = \text{BreedingStock} / \text{AveLifeTimeMink}$$

$$\text{AveLifeTimeMink} = 3$$

$$\text{Fertility} = 3.9$$

The whelp production is determined by the bitches and their fertility. The breeding stock is being replaced according to the 3 year average life time of minks. The fertility has varied significantly over the years, generally around 3.9. Other countries, such as Denmark, have experienced considerable fertility improvements due to sophisticated husbandry (reaching around 4.5 last year) (personal reference Norwegian Fur-Breeding Association).

### 1.4 Breeding Stock Pelt Production

$$\text{BrdStockPeltProduct} = \text{MAX} (\text{AgeRelatReplacement}, (\text{BreedingStock} - \text{BreednStockGoal}))$$

The breeding stock pelt production represents the pelt production from slaughtering breeding minks. There are two reasons for such slaughtering;

- the need for age related replacement; and
- the need for adjusting the breeding stock downwards (i.e. the difference between actual and desired breeding stock).

Whichever is the largest of the two, determines the slaughtering rate and the pelt production from the breeding stock.

## 2. Pelt Production and Sales

### 2.1 Pelt Stock

$$\text{PeltStock} = \text{PeltStock} + dt * ( \text{WhelpPeltProduction} + \text{BrdStockPeltProduct} - \text{SalesOfPelt} )$$

The pelt stock constitutes the pelts in stock ready for sale per Jan 1. It accumulates the slaughtering of breeding stock and whelps and is reduced by sales.

### 2.2 Sales of Pelt

$$\text{SalesOfPelt} = \text{PeltStock}$$

All the pelts on stock are assumed sold on auction in the Spring following late Fall slaughtering.

### 2.3 Whelp Pelt Production

$$\text{WhelpPeltProduction} = \text{WhelpProduction} - \text{Recruitment}$$

The production of pelts from whelps is determined by what remains from the whelp production after recruitment.

## 3. Breeding Stock Decisions

### 3.1 Desired Breeding Stock and Breeding Stock Goal

$$\text{BreednStockGoal} = \text{MIN} (\text{DesiredBreednStock}, \text{ProductionCapacity})$$

$$\text{DesiredBreednStock} = \text{BreedingStock} + \text{DesAdjBreedingStock}$$

$$\text{DesAdjBreedingStock} = (\text{SMTH1} (\text{ProfDetBreednStock}, 1.2) - \text{BreedingStock}) / \text{TimeAdjustmBrdStock}$$

$$\text{TimeAdjustmBrdStock} = 1$$

The breeding stock goal is the desired breeding stock, limited by the physical production capacity. The desired breeding stock is determined by the current breeding stock and the desired adjustment of that stock. This adjustment reflects the difference between the current and the slightly smoothed profit-determined breeding stock, to be eliminated over a 1 year average time for adjustment.

### 3.2 Profit Determined Breeding Stock

$$\text{RelatProfitability} = \text{SMTH1}(\text{NetFarmIncomePrHour}, 2.3) / \text{SMTH1}(\text{OtherIncome}, 3)$$

The profit determined breeding stock is assumed to be a function of the relative profitability in mink farming, i.e. the perceived profitability, compared to alternative forms of agricultural production. The profitabilities are smoothed (2.3 and 3 years respectively) to represent the time it takes to perceive them. This smoothing of the net farm income is done so as to tune the model to the changes in the breeding stock due to slaughtering. The table, representing the relationship between relative profitability and the indicated breeding stock, is portrayed in figure 4, and is tuned by the utilization of a Bayesian strategy.

The profitability of alternative farm production, i.e. the average net farm income per hour for the period under consideration, is available from the yearly publication of account results in agriculture and forestry, published by the Norwegian Agricultural Economics Research Institute (Norsk Institutt for Landbruksøkonomisk Forskning 1989). The results are averaged for around 1000 representative farms per year. For the years 1972 - 1989, individual farm data are available from a computerized data bank:

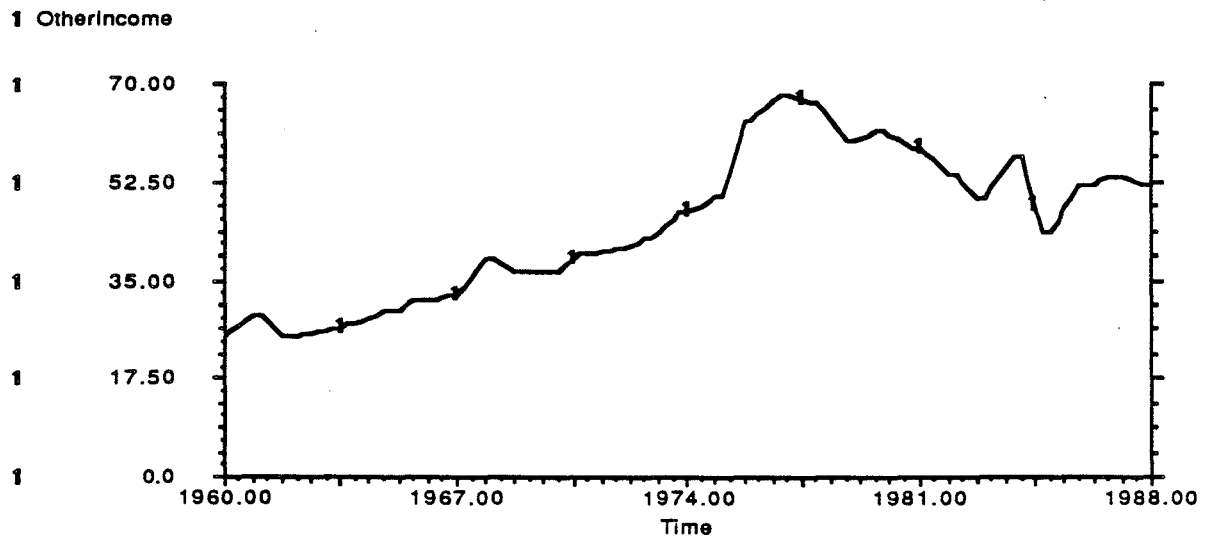

Figure 10: Alternative farming income per hour (NOK 1987).

### 3.3 Net Fur Farm Income Per Hour

$$\text{NetFarmIncomePrHour} = \text{ProfitPerPelt} * \text{Fertility} / 8.63$$

The net income per hour in mink farming is determined by the profit per bitch and the hours spent on each bitch; estimated to 8.63 hours (Streitlien 1970). The profit per bitch is determined by the profit per pelt times the number of pelts produced per bitch, i.e. the fertility.

#### 4. Production Capacity and Adjustments

##### 4.1 Production Capacity

ProductionCapacity = ProductionCapacity + dt \* ( CapacityAdjustment - Depreciation )

CapacityAdjustment = (DesiredCapacityAdj / TimeAjustCapacity)

Depreciation = ProductionCapacity / AveLifeTimeCapital

TimeAjustCapacity = 2.4

AveLifeTimeCapital = 30

Production capacity is increased by capacity adjustments and reduced through depreciation. Capacity adjustments take place when desired, with a 2.4 years average planning, financing, acquisition, and construction delay. The capital is depreciated corresponding to the 30 years average capital life time.

##### 4.2 Desired Capacity Adjustments

DesiredCapacityAdj = MIN (CapacityDiscrepancy, CarryCapacityRemCap)

CapacityDiscrepancy = MAX (DesiredBreednStock - ProductionCapacity, 0)

The desired capacity adjustment is a minimum of the adjustment required and what is financially feasible, i.e. the carrying capacity of the capital remaining after supporting the current breeding stock. The required adjustment amounts to any positive capacity discrepancy between the desired breeding stock and the current production capacity.

#### 5. Finances

##### 5.1 Carrying Capacity of Capital

CarryCapacityRemCap = WorknCapitalRemain / CapitalReqmPerMink

The carrying capacity of the remaining capital is the number of additional minks for which cages and feed can be provided within current financial constraints. It is the working capital left after having supported the current breeding stock, divided by the capital requirement per mink.

##### 5.2 Capital Requirement per Mink

CapitalReqmPerMink = VariableCostsPrMink + InvestmPrBreednMink \*  
(1 - OwnShareInvestments) / PayBackPeriod

PayBackPeriod = 10

The capital requirement per mink consists of the variable and the fixed costs per mink. The fixed costs are that part of the investment in capital equipment that is not covered by the farmers' own share of investments, distributed over a 10 years average payback period.

##### 5.3 Variable costs per Mink

VariableCostsPrMink = (ConsmpFeedPerPelt \* (FeedPrice / FeedConcentration)  
\* Fertility / (1 + (4 / 20))) \* (100 / 95)

Variable costs per mink is determined, on the basis of feed costs. The feed consumption is measured in kcal/pelt. To obtain the cost per pelt, we have to multiply by the feed cost, determined by the feed price per kilo through the feed concentration (kcal/kg). These are all exogenous factors varying over time (see below). Multiplying by the fertility yields the cost per bitch. To include the male breeding stock population, we divide by 24/20. As the feed costs generally constitute 95% of variable costs, we multiply by 100/95 to obtain the total variable costs per mink.

Historical average variable costs have been calculated from data published by The Budget Committee. The Norwegian consumer price index has been used to deflate to NOK 1987. The feed price has been falling, due to technological improvements, though enough to compete with Denmark. Moreover, feed concentration and the consumption of feed per pelt, have increased by 15 - 20 %, due to larger minks and improved feed preparation techniques, respectively (Prof. Anders Skrede, The Agricultural University of Norway):

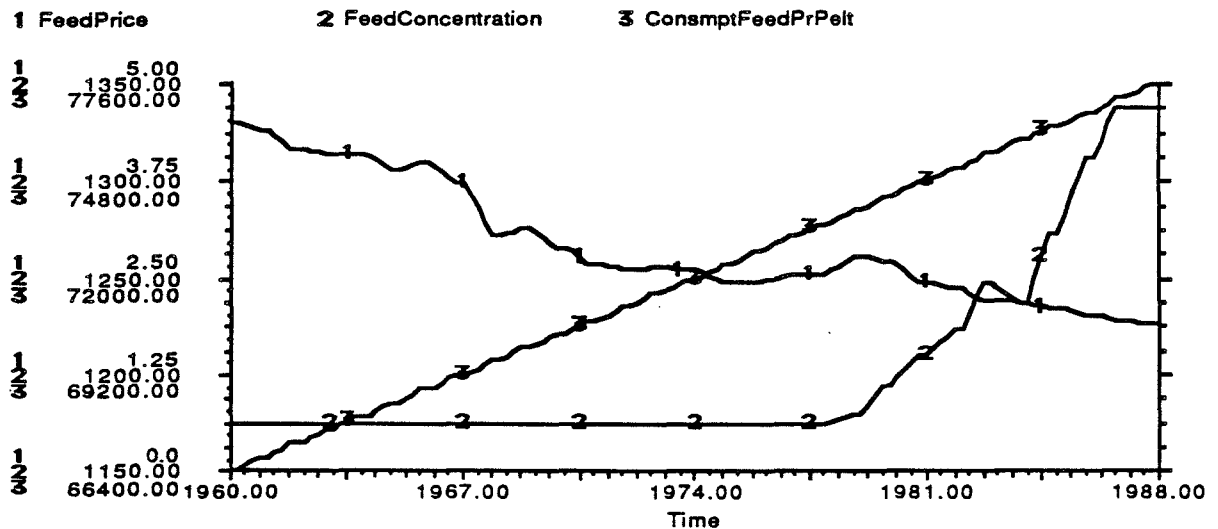

Figure 11: Feed prices (1987), feed consumption, and feed concentration.

#### 5.4 Working Capital Required and Remaining

$$\text{WorknCapitalRemain} = \text{MAX} ((\text{WorkingCapital} - \text{CurrCapitalRequirem}), 0)$$

$$\text{CurrCapitalRequirem} = \text{FixedCosts} + \text{CurrVariableCapReqm}$$

$$\text{CurrVariableCapReqm} = \text{MIN} (\text{ProductionCapacity}, \text{DesiredBreednStock}) * \text{VariableCostsPrMink}$$

The working capital, if any, remaining after supporting the current breeding stock, is the available working capital less the capital requirements imposed by the current breeding stock. The current capital requirements consists of fixed costs and current, variable capital requirements, indicated by the variable costs per mink. Provided there is capacity, the variable requirements are determined by the size of the desired breeding stock.

#### 5.5 Investments, Long Term Liabilities, and Fixed Costs

$$\text{LongTermLiabilities} = \text{LongTermLiabilities} + dt * (\text{InvestmentLoans} - \text{FixedCosts})$$

$$\text{FixedCosts} = \text{LongTermLiabilities} / \text{PayBackPeriod}$$

$$\text{InvestmentLoans} = \text{CapacityAdjustment} * \text{InvestmPrBreednMink} * (1 - \text{OwnShareInvestments})$$

$$\text{OwnShareInvestments} = 0.4$$

The long term liabilities are increased by investment loans and decreased by payments that constitute fixed costs at a rate corresponding to the 10 year payback period. Loans are used to cover investments beyond the farmers' own share of investments of 40 %. There are no data on farmers own share of investments, but labour constitute 40% of the input, of which the farmers may do all. In addition, farmers may contribute with wood products from their own forests.

The total investment each year is determined by the capacity adjustments made and the investments per new member of the breeding stock. These investments have been changing over time and have been calculated from data published in the yearly farm planning handbook (Norsk Institutt for Landbruksøkonomisk Forskning 1989) and the planning handbook in fur farming (Norges Pelsdyravslag 1985) and deflated to 1987 NOK, using the Norwegian consumer price index:

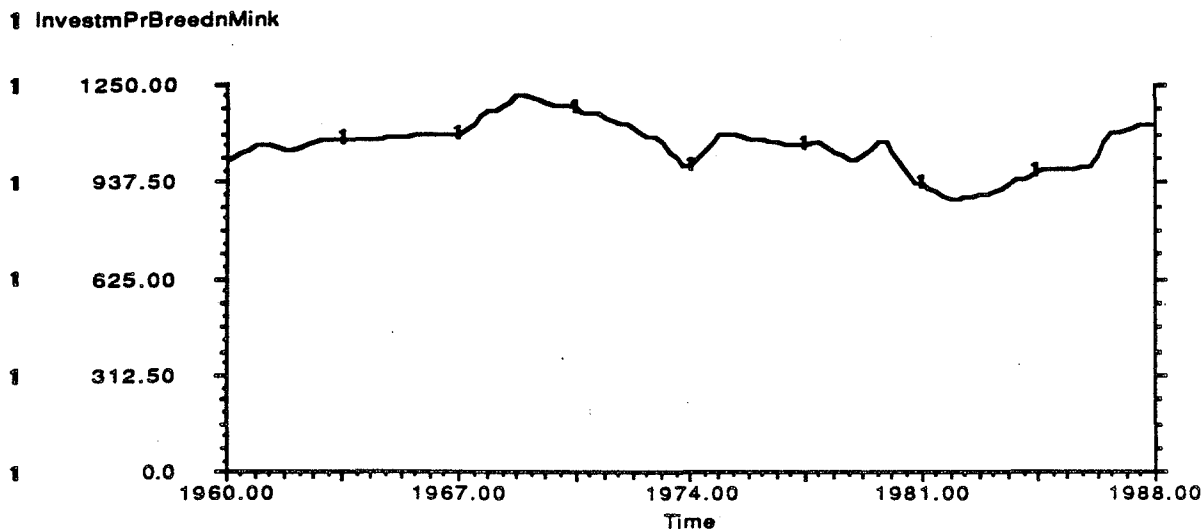

Figure 12: Investments per Unit of Breeding Stock.

### 5.6 Working Capital, including Loans

$$\text{WorkingCapital} = \text{Profit} * (1 - \text{PropensityToConsume}) + \text{DisposableLoans}$$

$$\text{DisposableLoans} = \text{TotalAssets} * \text{LoanFraction}$$

$$\text{LoanFraction} = 0.45$$

The working capital consists of profits and disposable (potential) loans. The loans at the farmers' disposal are determined by their total assets and a fraction, 45 %, of the total assets that may constitute the farmers' loan. This parameter has been subject to Bayesian estimation.

### 5.7 Total Assets

$$\text{TotalAssets} = \text{Profit} * (1 - \text{PropensityToConsume}) + \text{BreedingStock} * ((\text{Fertility} * (1 - 4 / 20)) + 1) * \text{HistMinkPeltPrice}$$

$$\text{PropensityToConsume} = 0.5$$

The total assets are generated from two sources;

- profits, less consumption, determined by the 50 % propensity to consume; and
- the value, determined by the mink price, of the minks, consisting of the breeding stock, and the whelps to be produced by the bitches (20/24 of the breeding stock) at current fertility.

The marginal propensity to consume the net farm income has been analyzed, based upon the material, used for net farm income estimation, using regression analysis on consumption (including taxes) versus

total net income for the period 1972 - 88. On data from individual farms, the marginal propensity to consume exhibited some variation. The average for the 17 years was 0.493. For the same period, the loan share of investments has been estimated to 0.43 in this material.

### 5.8 Profit

$$\text{Profit} = \text{SalesOfPelt} * \text{ProfitPerPelt}$$

$$\text{ProfitPerPelt} = \frac{\text{HistMinkPeltPrice} - \text{CostPerMink}}{(1 - (4 / 20)) * \text{Fertility}}$$

$$\text{CostPerMink} = \frac{\text{TotalCosts}}{\text{BreedingStock}}$$

$$\text{TotalCosts} = \text{FixedCosts} + \text{VariableCostsPrMink} * \text{BreedingStock}$$

The profit is determined by the number of pelts sold at the auction and the profit per pelt. This profit is the mink pelt price, obtained at the auction, minus the cost per pelt. The cost are determined from the cost per mink through whelps per mink (bitches per mink times fertility). The costs per mink are the total costs, consisting of fixed and variable costs, distributed over the breeding stock.

### 5.9 Mink Pelt Price

The mink pelt prices have been calculated from the annual report of the Norwegian Fur-Breeding Association (Norges Pelsdyravslag 1989), deflated to 1987 NOK, using the Norwegian consumer price index. They are portrayed in figure 2.

## Appendix B: References

- Asheim, L.J. (1990): Økonomien i pelsdyrnæringa. Melding fra Norsk Institutt for Landbruksøkonomisk Forskning. Oslo.
- Budsjettmemda for Jordbruket (1989): Jordbrukets totalregnskap 1987 and 88. Jordbrukets totalbudsjett 1989. ISSN 0800-7047. Yearly Publication. Oslo.
- Dansk Pelsdyravlerforening (1984): Minkproduksjon. I kommission hos Det kgl. danske Landhus-holdningsselskab. ISBN 87-7026-244-6. København.
- Fagerlind, A. (1969): Lønsamhet vid minkoppföding. Empiriska studier vid 24 minkgårder. Lantbruks-högskolan. Konsulentavdelningens stencilserie. Economi 13. UDK 631.143.6. Stockholm.
- Koskenranta-Kouki, S. (1982): En undersökning av pælsfarmers och fodercentralers lønsamhet och finansiering. Finsk Pelsdyrtidsskrift 19 - 21. Helsinki.
- Koskenranta-Kouki, S. (1986): Farmernas Produktionskostnader och lønsamheten. Note from Finlands Pelsdjuruppfödarens Förbund RF. Helsinki.
- Norges Pelsdyravslag (1989): Årsmelding og regnskap 1988. Oslo.
- Norges Pelsdyravslag (1989): Pelsdyrboken, 2. utgave. Oslo.
- Norsk institutt for landbruksøkonomisk forskning (1989): Driftsgranskninger i jord- og skogbruk. Regnskapsresultater 1988. S-077-89. Yearly publication. Oslo.
- Statistisk Sentralbyrå (1961): Jordbruksteljinga i Noreg 20. juni 1959. Norges Offisielle Statistikk XII 40. Oslo.
- Statistisk Sentralbyrå (1971): Jordbruksteljinga i Noreg 20. juni 1969. Norges Offisielle Statistikk A446. Oslo.
- Statistisk Sentralbyrå (1982): Jordbruksteljinga i Noreg 20. juni 1979. ISBN 82-537-2759-3. Oslo - Kongsvinger.
- Streitlien, O. (1970): Arbeidsforbruket i pelsdyrgården. Note Norges landbruksøkonomisk institutt. Oslo.