

# INTERVENTION FOR ORGANIZATIONAL LEARNING IMPROVEMENT

By

Mahmoud Ajami\*, Tavanir, Iran  
Alinaghi Mashayekhi, Sharif University of Technology, Iran  
Reza Sotudeh, University of Hertfordshire, UK

Jan. 2001

## ABSTRACT

Because of rapid environmental changes, the rate at which organizations learn may become the only sustainable source of competitive advantage. Organizations learn through their individuals. This article describes a method of intervention by a facilitator designed to enhance organization learning through changes in individuals' mental models and vision based on Senge's concepts and approach to organizational learning. Three power plants were used as the field for the research. The facilitator made several interventions in the management teams thinking process in several periods. In each period the nature and approach of the intervention was different. Interventions included: (1) introduction to basic theories of management principles, system thinking, and organizational learning, (2) facilitating the formation of shared vision process, (3) facilitating the formation of shared mental model process. In the second and third periods of the intervention, the discipline of dialogue was emphasized. The results and effectiveness of the interventions after each period were measured and evaluated using cognitive mapping methods.

**Keywords:** Individual Learning, Organizational Learning, Intervention, Vision, Mental Model, Team Learning, Systems Thinking, Cognitive Map

---

\* Corresponding author, e-mail: M.Ajami@Tavanir.org

# 1 Introduction

Nowadays, change is a characteristic of our environment and response to environmental changes, for adaptation, is the heart of any activity in an organization. The capability of detection and fill in the gap between the organization and the environment is accounted as a great competitive advantage. Those of organizations that have this advantage would be able to detect and correct their errors. The correction of errors embedded in behaviour change and “behaviour change requires changes in the theories that people use and in the learning systems of the organization” (Argyris 1999, P. 67). In this regard “The better organizations are at learning the more likely it is they will be able to detect and correct errors and to see when they are unable to detect and correct errors. Also the more effective organizations are at learning the more likely they will be at being innovative or knowing the limits of their innovation” (Argyris 1999, P. xiii). That is why, in point of Argyris view, “learning organization is a competence that all organization should develop” (Argyris 1999, P. xiii).

“Some management thinkers believe we are entering an age of globalisation in which building and leveraging knowledge will be the key to success” (Steven97, P.148). “In fact, I would argue that the rate at which organizations learn, may become the only sustainable source of competitive advantage, especially in knowledge-intensive industries” (Stata 1989, P. 64).

But how this changes should take place in an organization? Peter M. Senge, in his book The fifth Discipline, has described the learning organisation (LO) as one which is equipped with at least five disciplines: personal mastery (PM), mental models (MM), shared vision (SV), team learning (TL) and systems thinking (ST).

The present paper describes a method of intervention by a facilitator that is designed to enhance organization learning through changes in individuals’ mental models and vision based on Senge’s concepts and approach to build up a learning organization. The effectiveness of the interventions, were measured and evaluated using a cognitive mapping method. Iran Power Industry was the domain of the research and three base loaded power plants were chosen as the field of the research.

## 2 Intervention Plan

The applied research was arranged in four phases and three periods. In each phase a cognitive map of the managers was drawn and, in each period, some interventions were implemented. Addressees of the research are senior managers.

The objectives of the three intervention periods were as follows:

First period: Preparing the groundwork foundations in managers' thought. In this regard, basic theories of the research, based on literature, were discussed. It was called transfer of basics (TOB).

Second period: Developing shared vision of managers from the power plants. In this regard, transfer of basics was continued and a shared vision (SV) process was implemented.

Third period: Changing the managers' mental models from what they are to what is implied by the managers' shared vision. Transfer of basics (TOB), from first and second periods, was continued and a shared mental model (SMM) process was implemented.

In each phase, the managers' cognitive map (CM), in respect to power plant performance was drawn by the researcher. Consequently, four cognitive maps (CM) were drawn, from CM1 up to CM4 for each manager.

By recording cognitive maps in consequent phases, it is possible to trace the change of a person's thought as time passes, and makes it possible to measure the effectiveness of interventions that have been implemented in managers' thought.

Figure 1 shows scheduling and activities of the research in brief.

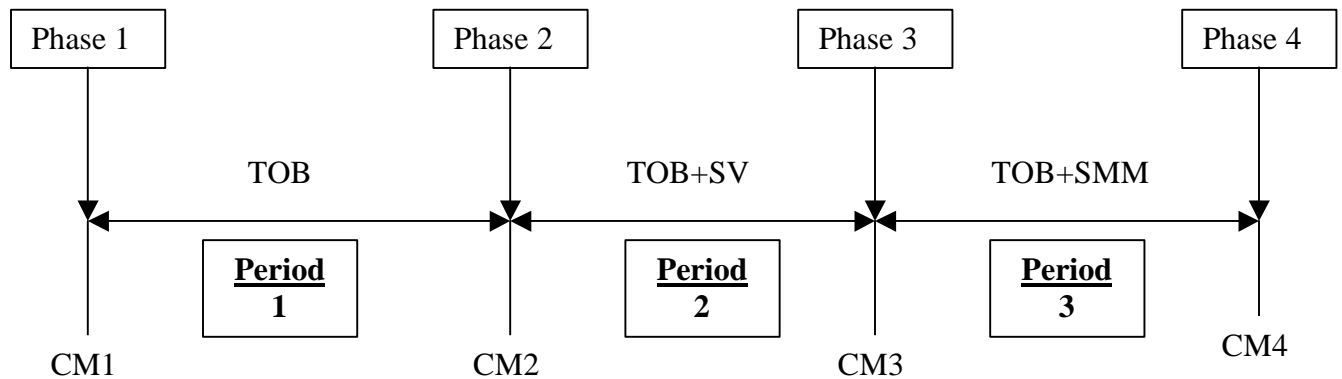

Timing and Activities of the Research

Fig 1

CM: Cognitive Map,  
SMM: Shared Mental Models.  
SV: Shared Vision,  
TOB: Transfer of Basics,

## 2.1 The Kinds of Interventions

As figure 1 shows, during each period there was intervention into the managers' thoughts.

The purpose of the interventions, in each period, was:

Period1: To prepare the ground works and background

Period2: To develop the Managers' shared vision

Period3: To develop Managers' shared Mental Models.

### 2.1.1 Preparing Groundwork and Background

Transfer of basic theories to the managers was the backbone of this period. TOB includes the following theories and models.

- ◆ Management functions based on literature
  - Holding management functions workshop as a practice
  - Investigation of obstacles and facilitators in respect to implementation of the management functions
  - Presentation, for at least one of the relevant subjects in management functions, by each of the managers.
- ◆ System dynamics
  - Causal Linear thinking and causal cycle thinking
    - The necessity of substituting causal cycle thinking for causal linear thinking with.
  - Team practice in system dynamics thinking and methodology
    - Team practice in the methodology of system dynamics was done in two kinds of activities: (1) drawing the causal diagram of the different working fields in the power plant company and (2) story telling in events of the power plant. Story telling leads to causal diagram of the story and determination of the related archetype, according to the related literature
    - For each working field in the power plant, a team was formed. A team was comprised of managers whose duties were related to each other. In the research, the team was considered as an infrastructure and was used in different activities during the three periods.
- ◆ .Theory of Organisational Learning
  - Five disciplines (PM,SMM,SV,TL,ST)
  - Presentation by each manager of at least in one of the relevant subjects in each learning organization discipline.

### 2.1.2 Developing Managers' Shared Vision

Developing the shared vision of the managers from power plant Company consisted of the following processes.

- ◆ Boosting the individual visions in different personal affairs generally, and boosting the individual vision from the power plant specifically.
- ◆ Developing the vision of each team from each power plant.
- ◆ Developing the shared vision of all the managers.

The last two processes relied on the discipline of team learning (TL) with a concentration on dialogue.

Shared vision of the managers was comprised of two parts: the general statement and dimensions. The general statement describes the desired view of all the managers for the future horizon (five years in this research). Since the general statement does not clearly lead to actions, it therefore needs a section to spread and translate it in the different fields of company.

The dimensions of the vision are clear translations of the vision statement in different fields of the company. From the literature's point of view, there are different dimensions, including: technical, financial and economic, human resources, satisfaction, systems and management, and environmental. The clearer each dimension of the statement is, the more it is used in executing the vision. It is necessary that all mentioned dimensions be selected; it is up to the managers' preferences.

## **2.1.3 Developing Shared Mental Models**

According to the literature, a person's behavior is rooted in his/her mental models. If the managers would like to lead the company toward their shared vision, they need to change their mental models to what their shared vision implies. The mentioned change occurs from a cycle containing surfacing, testing and improving. Operation of the cycle is called mental models management that leads to change of mental models. In this research mental models management was done by means of two interrelated activities:

- ◆ Working in dimensions of shared vision
- ◆ Working on assumptions of the managers in relation to the dimensions of shared vision.

### **2.1.3.1 Working in Dimensions of Shared Vision**

This activity started by assigning a manager as responsible for each dimension. He/she did the steps below to prepare and provide the issues, which were then shared among the managers. The steps were:

1. Determination of the dimension index/indices
2. Definition of the index/indices and calculation of its formula from the literature's point of view.
3. Data gathering of the functional elements of index/indices formula for the last few years
4. Calculation of the index/indices and drawing the related curves.

5. Forecasting the index/indices curves for next five years according to present trends.
6. Drawing the indices curves for next five years according to what has been determined in the shared vision of the managers.  
Note: Steps number 5 and 6 indicate the “**gap**” between the current trend and the path which comes up from the shared vision.
7. Gap analysis
8. Determination of drivers and related actions to fill the gap.
9. Presentation of the outcomes of above steps to the managers.
10. Continuation of dialogue and discussion among the managers in outcomes of the above steps to achieve to the relative accepted sharing, among the managers

### **2.1.3.2 Working on Assumptions of the Managers**

Working on assumptions of the managers was done as follows:

- 1) Using notes and managers’ behaviour during the interventions, the researcher prepared the assumptions of the managers with respect to their shared vision and its dimensions.
- 2) Studying the assumptions of all the managers in sessions.
- 3) Holding dialogue sessions among the managers about their assumptions, and preparing new lists of the managers’ assumptions with respect to the shared vision and its dimensions.

Steps 2 and 3 were repeated every six months. In each iteration, the list from the previous time would be the input of the sessions.

## **3 Action Plan**

The action plan comprised three main subtitles:

- Preparatory Steps
- Data Gathering
- Duration of action plan: phases and periods

### **3.1 Preparatory Steps**

The participation of power plant managers in the research project necessitated the following prerequisites:

- A- The research should be a formal activity, approved by the top management. This prerequisite was met by:
- 1) Acceptance and approval of the research subject by the Deputy Minister for Power Affairs and also by the Dispatching and Operations Deputy of Power Affairs.

- 2) Selection of some power plants, as field of the research, by authorities mentioned in the previous item.

These activities led to selection of three power plants as fields of the research, called power plants 1,2 and 3.

- B- Managers of the selected power plants should be generally informed about the research and its benefits, proportionate to. This prerequisite was met by:
- 1- Description of the research project and its benefits to the CEO of the power plant company to persuade him.
  - 2- Description of the research project and its benefits for all senior managers, so that they would be oriented to the research.

## **3.2: Data Gathering**

Data gathering was comprised of two parts:

- Observing and recording the project's applied activities
- Drawing the cognitive map of each manager each, in every phase of the research.

### **3.2.1 Write down the Research Activities**

Each session and every contact with the managers were written down sequentially and a booklet was prepared, for each period of the research, for each of the power plants. The booklets were an important resource of the research that made it possible to access the following:

- The different types of the activities, implemented during the periods of the action plan
- The exact time table of the activities
- The participation rate of the managers
- The causes of accelerating or delaying the action plan.
- The assumptions of the managers with respect to different issues.
- Gradual changes in the managers' thought and behaviour, individually and collectively.

### **3.2.2 Drawing the Cognitive Maps of the Managers**

Cognitive maps of the managers were drawn in each phase of the research. The purpose of this action was to map the cognition of each individual manager with respect to the positive and negative factors influencing power plant performance. For this purpose, the following steps were implemented, by the researcher:

- 1- Listening to the manager's descriptions, in a personal session, about how to improve power plant performance.
- 2- Documenting the manager's descriptions in a cognitive map format.

- 3- Having the cognitive map approved by the manager.  
Note: Experimentally, the researcher found that, for the managers, it is far easier to state their ideal situation first. By contrast, it is far more difficult for them to state the current situation first. That is why drawing an ideal map was selected as a medium to get the cognitive maps of the current situation. The prepared map contained the manager's ideal factors and did not present the current situation; thus it was called the "ideal map."
- 4- Asking the managers about differences between the map of the current situation and the ideal map.
- 5- Drawing the individual cognitive map with respect to the current situation.
- 6- Approval of the cognitive map by the manager.
- 7- Improving the cognitive map for the last time, by the manager, in a two-day opportunity after each session.

Note: The cognitive map of the current situation was used as an element in the measure used to determine the interventions' effectiveness.

## **3.3 Structure of the Action Plan**

Figure 2 shows the structure of the action plan. In this regard the following should be described.

- ◆ Differences of actions taken in different power plants
- ◆ The time table of the research

### **3.3.1 Differences of Actions in Different Power Plants**

Action plan has been shown in figure 2. From the beginning, the action plan designed with some differences in three power plants. The differences are one of the evaluation basis to determine the intervention effectiveness. As Fig. 2 indicates, the differences are as follows:

- ◆ In power plant 3 there was no phase one and period one, and consequently the intervention of transfer of basics (TOB) in this power plant was not as strong as the other two power plants.
- ◆ Power plant 3 was awarded ISO-9002 in a small section of the company before the start time of the applied research. Power plant 1 was seriously engaged in the process of ISO 9002 award during the periods 2 and 3, and power plant 2 was not involved in getting ISO during the research project.

Note: According to experts' acknowledgements, the ISO-9002 award in a small part of power plant 3 was not powerful enough to be efficient. This assessment by the experts has been corroborated by the present research's results, as we will see later.



### 3.2 Time Table of the Applied Research

Table 1 shows the timetable of the research. It should be noted that obtaining approval of the research from the power plant managers took about two months. Therefore, real time for start point of the research would be 22 July 1998.

Periods	From	To	Duration
1	22 Sep. 1998	20 Jun. 1999	9 Month
2	21 Jun. 1999	20 Dec. 1999	6 Month
3	21 Dec. 1999	20 Jun. 2000	6 Month

Table 1

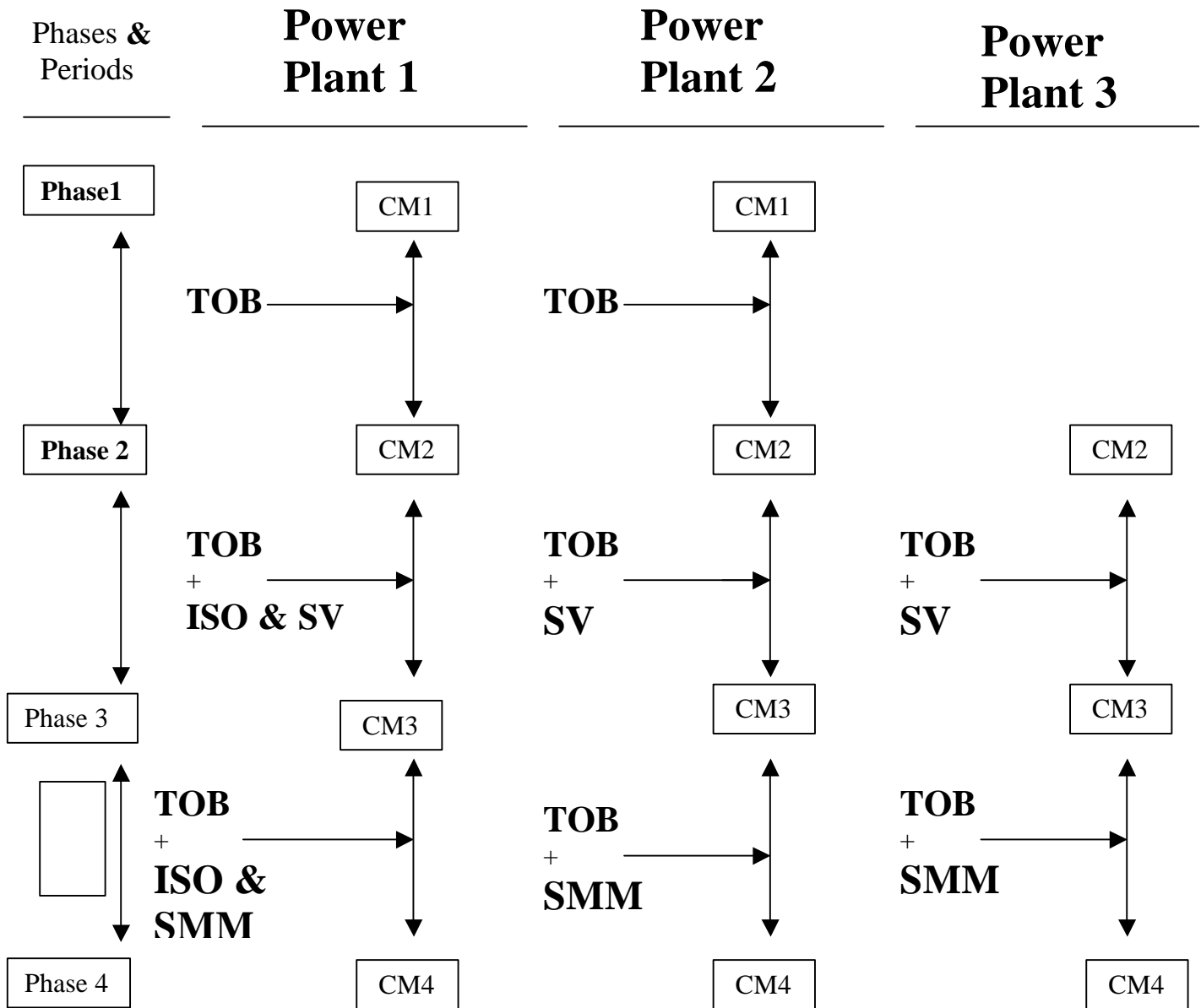

# ACTION PLAN

Fig. 2

## 4 Cognitive Maps

In each phase of the action plan (refer to Fig.1 and Fig.2) the cognitive maps of the managers were drawn. Therefore, there are four sequential cognitive maps for each of the managers in power plants 1 and 2, but only 3 sequential cognitive maps for each of the managers in power plant 3.

### 4.1 Cognitive Map Contents

A cognitive map comprises of some factors and the relationships among them. A factor could affect one or more other factors. The effect could be positive or negative, depending on the manager's thought.

At the beginning of the first period (that is phase one) and also at the end of each periods (that is phases 2 through 4), the cognitive maps of the managers were drawn by the researcher. This was done in an interview between the researcher and a manager. Each interview started with the question **“What are the factors, which have influence on the power plant performance?”**

The manager began to describe his views about the question while researchers drew the map accordingly. The length of the interview was open-ended, but experience showed that two hours was enough. Managers had another one day opportunity, after interview, to add to the cognitive map if he remembered more ideas in response to the question.

This research used the cognitive map as a technique to capture the thought of the managers with regard power plant performance. This made it possible to trace the changes in one person's thought over time, and compared the managers' thought, with each other with respect to the similarity or differentiation of their thoughts. For this purpose, a database was developed as a tool.

### 4.3 Evaluation of the Cognitive Maps

Cognitive maps are the most important measure of the research. Cognitive maps capture the effectiveness of the interventions, making it possible to trace the evolution of management thought.

Evaluation of the cognitive maps consisted of two subsections:

- ◆ Evaluation of the cognitive map tables
- ◆ Evaluation of the cognitive map curves

### 4.3.1 Evaluations of the Cognitive Maps Tables

The main purpose of this evaluation was to find a rational relationship between the interventions and the maps. Interventions were implemented in accordance with the action plan (Figure 2), with a hypothesized effect on the managers' thought. So, refer to the action plan in Fig.2 and keep in mind the various kinds of interventions in respect to each power plant, definitely.

#### 4.3.1.1 Evaluation of Table of P

P indicates the number of factors that have been used in one set of maps belong to the the managers of a power plant in a single phase. So, this table will contain the columns: PPID (Power Plant IDentification) and P for each of phases. Following is the table of P for three power plants. Trend of P and its changes in each power plant is the base of analysis in this section. Following is a description of the analysis.

Table of P

Power Plant	P			
	Phase1	Phase2	Phase3	Phase4
1	181	122	121	115
2	120	83	95	65
3	-	51	77	33

Table 2

- ◆ In a total view, trend of P, indicates a rational decrease toward an optimum number. Although it is not known any optimum number for P but the magnitude of P in phase1 is so high that experts consensus estimate it as a high value and optimum number is much more lower than that. So the mentioned trend indicates that the interventions, planned for the research, played an effective role and has been efficient.
- ◆ In phase1, there is an outstanding trend of decrease from phase 1 up to phase 4 although the difference between phases 2&3 is not meaningful. In this regard it will be described soon.
- ◆ There is a downward mutation between Phase1 and Phase2 in power plants. It indicates that intervention of transfer of basics (TOB) has played an effective role and has been efficient.
- ◆ In power plants 2 and 3, there is an upward mutation in magnitude of P in Phase3 compare to Phase2 while there is no meaningful difference in power plant1 in the same phases. It is remarkable that the interventions in power plants 2 and 3 are the same (Concentration on building up shared vision) and different compare to power plant1. In power plant1, the interventions are what have been done in PPID2&3 plus process of achieving ISO-9002 award. This indicates that building shared vision played a scattering role in the managers' thought while process of ISO-9002 award has played a controlling role in scattering of thought.
- ◆ All of three power plants have a decrease in Phase4 compare to Phase3. It indicates that the intervention, process of shared mental models, played a controlling role in scattering of thought and it has converged the managers' thought towards sharing.

- ◆ Power plants 2 and 3 have an upward mutation in phase 3 compare to phase 2 and have a downward mutation in phase 4 compare to phase 3, while there is no mutation in power plant 1 in the same phases. It means that, in power plant 1, scattering was controlled from the beginning and consequently there are no upward mutation in magnitude of P. This behaviour indicates that process of ISO-Award has the homogeneity of the process of shared mental models.

#### **4.3.1.1.1 Consequences of Table P Evaluation:**

Intervention of the research has played an active role to converge the managers toward sharing.

Interventions played the role of rationalising to the thoughts.

Transfer of basics (TOB) played an active role to converge the thoughts from dispersion.

Process of shared vision (SV) plays scattering role in the thoughts

Process of ISO award is considered as a process of shared mental models and plays an active role in sharing of the thoughts.

Process of shared mental models (SMM) controls, scattering of the thoughts.

Process of shared vision without process of shared mental models could be risky.

#### **4.3.1.2 Evaluation of Table of NOF**

NOF stands for number of factors and it indicates the total number of factors, which is used in a cognitive map by means of a manager. In this regards it is used two indices: Av\_NOF and R\_NOF.

Av-NOF stands for average of NOF and indicates the average of NOF, which is used in cognitive maps of the managers in a power plant in a phase.

R-NOF stands for the range of NOF and indicates the range of NOF used in cognitive maps of the managers, in a power plant, in a phase.

According to the above the table of NOF contains the columns: power plant, phases 1 up to 4 and rows: Av- NOF and R- NOF for each power plant.

The table of NOF has been shown in the Table 3 for 3 power plants. Trend of Av-NOF (Average of NOF) and R-NOF (Range of NOF) is the base of analysis in this section.

- ◆ Trend of Av\_NOF and R\_NOF correspond with the trend of P changes, so the same evaluation, mentioned in section 5.1.1, is valid.

**TABLE OF NOF**

PPID	Index	PhID1	PhID2	PhID3	PhID4
1	Av_NOF	18	14	19	19
	R_NOF	15	18	20	16
2	Av_NOF	18	14	21	20
	R_NOF	9	9	15	7
3	Av_NOF	-	12	28	14
	R_NOF	-	13	22	5

**TABLE 3**

#### **4.3.1.2.1 Consequences of Table of NOF Evaluation**

Due to similarity between the evaluations of P table and above table, the same consequences, described in section 4.3.1.1, is worthy and they are approved.

#### **4.3.1.3 Evaluation of Table of “Range of Matrix Distance” (R\_MD)**

MD stands for matrix distance and it is an index that shows the proximity of two person in thinking about a definite subject, here in this research, the subject is: power plant performance. For more details about MD index refer to Langfield-Smith (1992).

R\_MD stands for rang of MD and indicates the range of changes in MDs belong to the managers of a power plant in a phase.

So, table of R\_MD contains the columns of PPID and R\_MD. Column of R\_MD is designed to contain four phases. (Table 4)

Matrix distance (MD) is a measure to compare two cognitive maps to determine the proximity of individuals, two by two. The smaller is MD, the more is proximity of managers’ thoughts in respect to the subject.

Considering to the vast changes of P in different phases, MD itself can not be valid, that is why the range of MD (R\_MD) changes has been chosen as the base of analysis in this section.

Table 4 shows the trend of R\_MD for 3 power plants in four phases.

Following is the interpretation of the table.

- ◆ In phases 1 & 2 there are two samples in power plants 1 and 2 with different changes, so it is not meaningful.
- ◆ Trend of changes in phases 2,3&4 are the same as trend of changes in P, evaluated in section 6.2.1, so the same evaluation, is valid.
- ◆ In table of R\_MD, in power plant1, a downward mutation, from phase2 to phase3, is seen. It indicates the strong effectiveness of ISO-Award process in controlling the scattering of thoughts, resulting from shared vision process. This behaviour approves the same result, mentioned in table P evaluation, firmly.

Table of “Rangr of Matrix Distance” (R\_MD)

Power Plant	R_MD			
	Phase1	Phase2	Phase3	Phase4
1	42	56	35	31
2	21	18	28	22
3	-	22	33	28

Table 4

#### 4.3.1.3.1: Consequences of Table of R\_MD Evaluation.

Due to similarity between the evaluations of P table and R\_MD table, the same consequences, described in section 4.3.1.1.1 is applicable as well.

### 4.3.2 Evaluation of Cognitive Maps Curves

The following describes the contents of curves, used to compare and analyze cognitive maps in different phases:

- ◆ Curve of (NOCF , F\_NOCF)

NOCF stands for number of common factors in a power plant and defines the number of managers, who are common in a factor in a phase. F\_NOCF stands for Frequency of NOCF. So, the higher is NOCF, the higher is sharing in managers’ thoughts in respect to power plant performance and also the higher is F\_NOCF, the higher is sharing among the managers

- ◆ Curve of (NOCR , F\_NOCR)

NOCR stands for number of common relations in a power plant and defines the number of managers, who are common in a relation in a phase. F\_NOCR stands for frequency of NOCR in a phase in a power plant. A relation is defined as two factors: factor1 and factor2 and affect of factor1 on factor2, positive or negative, on the cognitive map. So the components of a relation are factor1, factor2 and effect of the first one on the second. So the higher is NOCR, the higher is sharing among the managers and also, the higher is F-NOCR, the higher is sharing among the managers.

### 4.3.2.1 Rules of Interpretation, for the Curves Movement, in Consequences Phases

According to the above definitions, the mentioned curves move from one phase to the other phase, based on the rate of intervention effectiveness. The more efficient, the more movement of the curve to the right and upward and the more rotation of curve slope from negative toward positive.

Following show the above descriptions, graphically.

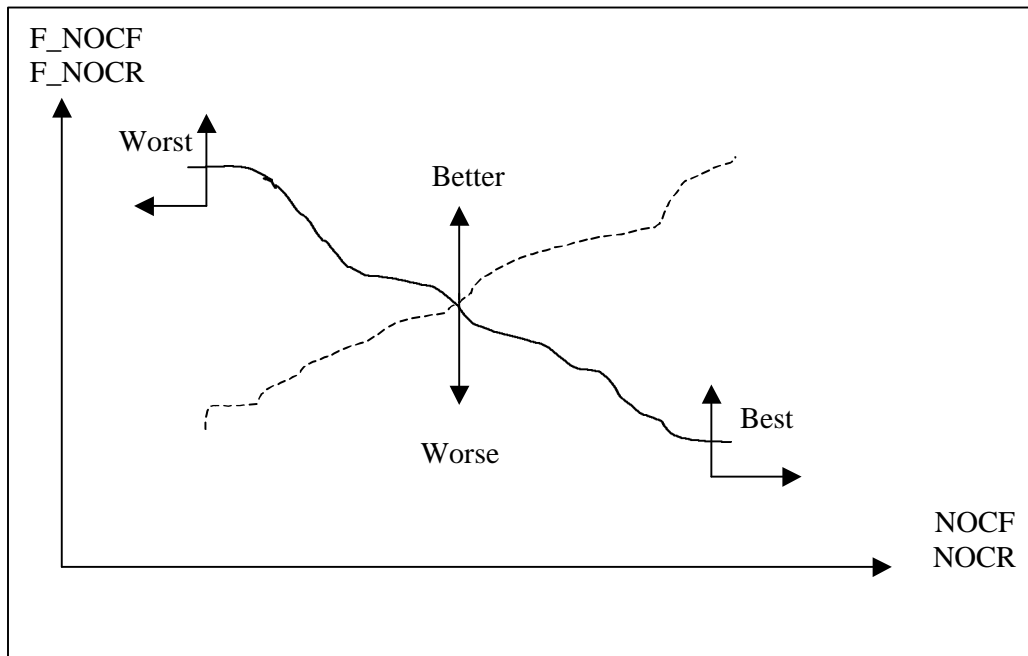

Fig. 3

According to the above figures, it is possible to define some rules to facilitate the interpretation of the curves.



### **Rules for Interpretation of the Curves**

- R1- The movement to the right, indicates more sharing among the thoughts and vice versa the movement to the left implies dispersion among the thoughts.
- R2- The more shortening of the curve length along to the x axis the more sharing among the thoughts and vice versa.
- R3- The more prolonging of the curve altitude along to the y axis the more sharing among the thoughts and vice versa.
- R4- The more change of the curve slope form negative to positive, the more sharing among the thoughts and vice versa

#### **4.3.2.2 Interpretation of the curves: (NOCF, F\_NOCF) and (NOCR, F\_NOCR)**

According to the already mentioned rules, the curves of NOCF and NOCR are analysed. In interpretation of the curves the following notes should be considered:

- ◆ Each figure contains four curves belongs to four phases and clearly show the movement of curve in respect to different phases.
- ◆ Factor number one (i.e. Power Plant Performance) has not been taken account in NOCF because this factor is the main theme of the question for drawing the cognitive map. In other words the managers have not mentioned the factor number one.

Regarding to the above notes, the curves would be interpreted. It is reminded that in some cases that the curves of four phases are too closeness to each other, the figure of curves has been appeared in two mod of y axis: compressed and non-compressed.

Tables 5 and 6 contains variables of (NOCF, F\_NOCF) and (NOCR, F\_NOCR) consequently for three power plants (PPID = 1,2,3). The tables are references of the curves.

NUMBER OF COMMON FACTORS (NOCF)

Power Plant	Phase1		Phase2		Phase3		Phase4		
	NOCF	F_NOCF	NOCF	F_NOCF	NOCF	F_NOCF	NOCF	F_NOCF	
1	1	151	1	97	1	82	1	75	
	2	17	2	11	2	14	2	23	
	3	7	3	7	3	5	3	4	
	4	1	4	3	4	4	4	1	
	5	2	5	1	5	3	6	1	
	6	1	9	1	6	3	8	1	
	7	1	11	1	7	2	9	2	
	-	-	-	-	8	2	10	1	
	-	-	-	-	9	1	11	3	
	-	-	-	-	13	3	12	1	
	-	-	-	-	14	1	13	1	
	-	-	-	-	-	-	14	1	
	2	1	105	1	65	1	71	1	37
		2	6	2	9	2	8	2	13
3		4	3	4	3	8	3	5	
4		3	4	2	6	4	4	2	
6		1	7	2	7	1	5	1	
-		-	-	-	8	2	6	1	
-		-	-	-	-	-	7	5	
3	-	-	1	45	1	47	1	19	
	-	-	2	4	2	12	2	2	
	-	-	3	1	3	9	3	5	
	-	-	-	-	4	4	4	2	
	-	-	-	-	5	4	5	4	
	-	-	-	-	-	-	-	-	

Table 5

NUMBER OF COMMON RELETIONS (NOCR)

Power Plant	Phase1		Phase2		Phase3		Phase4	
	NOCR	F_NOCR	NOCR	F_NOCR	NOCR	F_NOCR	NOCR	F_NOCR
1	0	60	0	55	0	6	0	11
	1	20	1	25	1	3	1	15
	2	8	2	6	2	3	2	9
	3	3	3	3	3	1	3	7
	-	-	4	1	4	9	4	14
	-	-	6	1	5	16	5	9
	-	-	-	-	6	17	6	7
	-	-	-	-	7	15	7	2
	-	-	-	-	8	5	8	6
	-	-	-	-	9	6	9	2
	-	-	-	-	10	5	10	6
	-	-	-	-	11	1	11	1
	-	-	-	-	12	1	12	1
	-	-	-	-	13	2	14	1
-	-	-	-	14	1	-	-	
-	-	-	-	-	-	-	-	
2	0	18	0	16	0	5	2	3
	1	9	1	14	1	10	3	1
	2	4	2	5	2	3	4	2
	3	2	3	1	4	4	5	6
	4	2	-	-	5	2	6	2
	6	1	-	-	6	1	7	3
	-	-	-	-	7	1	8	1
	-	-	-	-	8	1	10	2
	-	-	-	-	9	1	13	1
3	-	-	0	9	4	5	3	2
	-	-	2	1	5	3	4	3
	-	-	-	-	6	1	5	2
	-	-	-	-	12	1	6	1
	-	-	-	-	-	-	7	1
	-	-	-	-	-	-	8	1

Table 6

### 4.3.2.2.1 Curves of power plant one (PPID=1)

Followings, the curves of (NOCF, F\_NOCF) and (NOCR, F\_NOCR) belong to power plant 1 are shown and evaluated.

#### 4.3.2.2.1.1. Curves of (NOCF, F\_NOCF)

Figures 4 and 6 represent the curves of (NOCF, F\_NOCF) in two modes: congested and non-congested in y-axis.

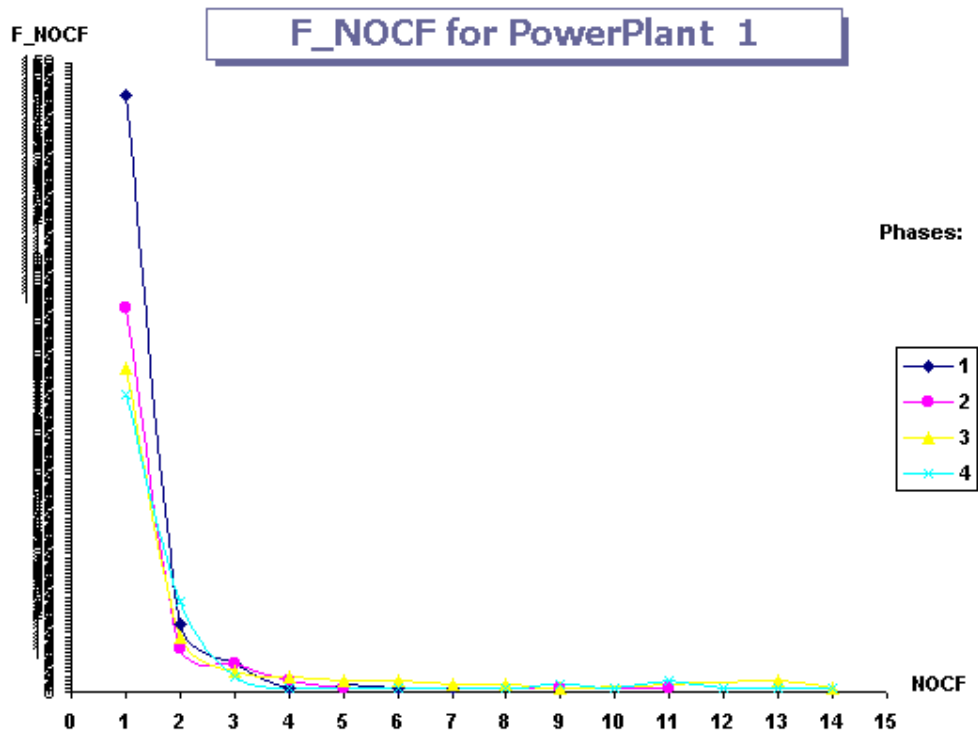

Fig. 4

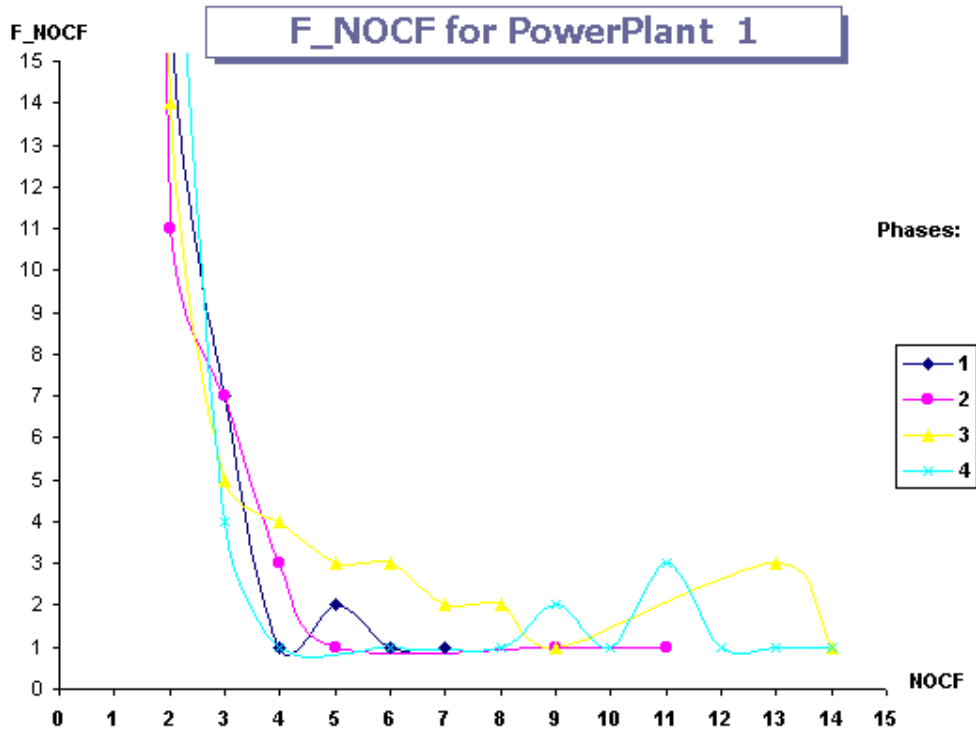

Fig. 5

As the figures show there is a move to the right and, totally, indicates that the conditions of managers' thought are getting better and better, towards the sharing and, in details, the followings describe the effectiveness of the interventions:

- ◆ A downward mutation in start point of curves in second phase compare to first phase indicates the efficiency of Transfer of Basics (TOB).
- ◆ Dropping of start point of each curve, in each phase in compare with previous phase is continuous and indicates the effectiveness of Interventions gradually.
- ◆ The last point of curve, on NOCF axis, for four phases are 7,11, 14 & 14 that shows the movement of the curve to the rightward and it means more sharing in each phase compare to the previous phase.
- ◆ Totally, the curves are moving rightward that indicates, interventions are efficient and sharing is increasing continuously

#### 4.3.2.2.1.2 Curves of (NOCR, F\_NOCR)

Figures 7 represent the curves of (NOCF, F\_NOCF)

As the figures show there is a move to the right and, totally, indicates that the conditions of managers' thought are getting better and better, towards the sharing and, in details, the followings describe the effectiveness of the interventions in relation to the curves.

- ◆ In start points of the curves, there are a downward mutation that indicates the high efficiency of the interventions totally.
- ◆ High downward mutation in start point of phase 3 to phase 2 indicates that shared vision process plus ISO award process jointly made synergy and the synergy approves the proper background which has been built up by transfer of basics.
- ◆ The last points of the curves on the NOCR axis are: 3,6,14 and 14 that show the movement of the curves towards right and indicate the more sharing based on interventions.
- ◆ There is a mutation between last points of phases 2 and 3 (NOCR = 6 & 14) that indicates the synergy comes up from linked intervention of shared vision process and ISO-Award process.

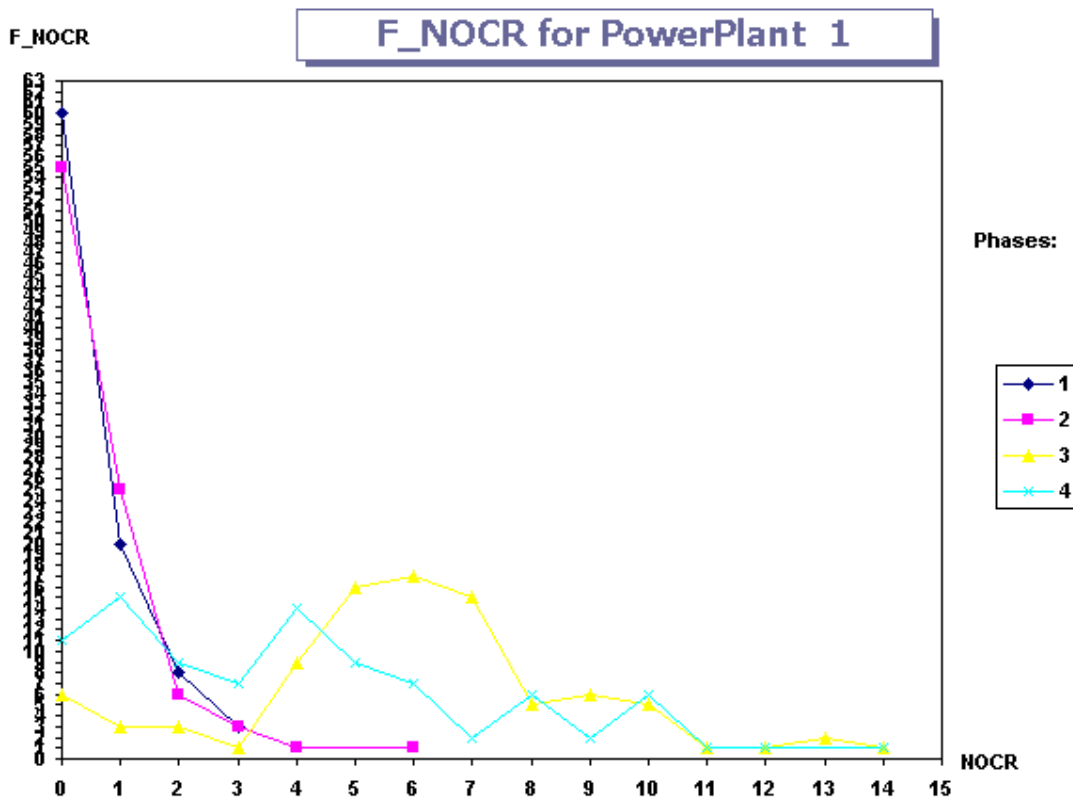

Fig. 6

#### 4.3.2.2.2 Curves of power plant 2 (PPID=2)

Followings, the cures of (NOCF, F-NOCF) and (NOCR, F\_NOCR) belong to PPID=2 are shown and evaluated.

##### 4.3.2.2.2.1: Curves of (NOCF, F\_NOCF)

Figures 7 and 8 represent the curves of (NOCF, F\_NOCF) in two modes: congested and non-congested in y-axis.

Followings are the interpretation of the curves:

- ◆ There is a downward mutation in start points of the curves that indicates the efficiency of Interventions to the sharing of managers' thought.
- ◆ The last points of the curves are 6, 7, 8 & 7. It is noticed that the number of managers in sequences phases are 9, 9, 8 & 7. So, the last points of the curves show a movement of the curve towards right and indicates higher sharing in managers' thought but it is not strong enough.
- ◆ Starting point of phase 3 is more than phase 2 and indicates the intervention between phases 2 & 3, shared vision process, caused scattering in managers' thought but the downward mutation in start point in phase 4, indicates that the intervention, shared mental models process (in other words mental model management has controlled the scattering, resulted from shared vision process.
- ◆ Regarding to the different number of managers in different phases: 9, 9, 8, 7 respectively; there is a slope rotation, from negative to positive that indicates the light effectiveness of interventions.

#### 4.3.2.2.2 Curves of (NOCR, F\_NOCR)

Figure 9 represent the curves of (NOCF, F\_NOCF).

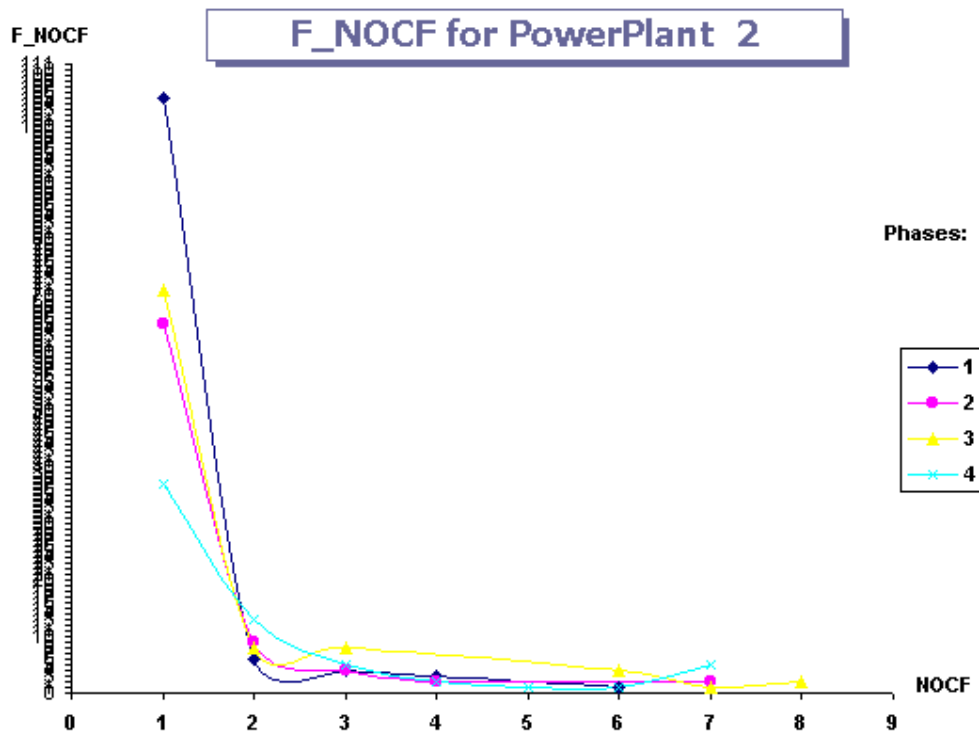

Fig. 7

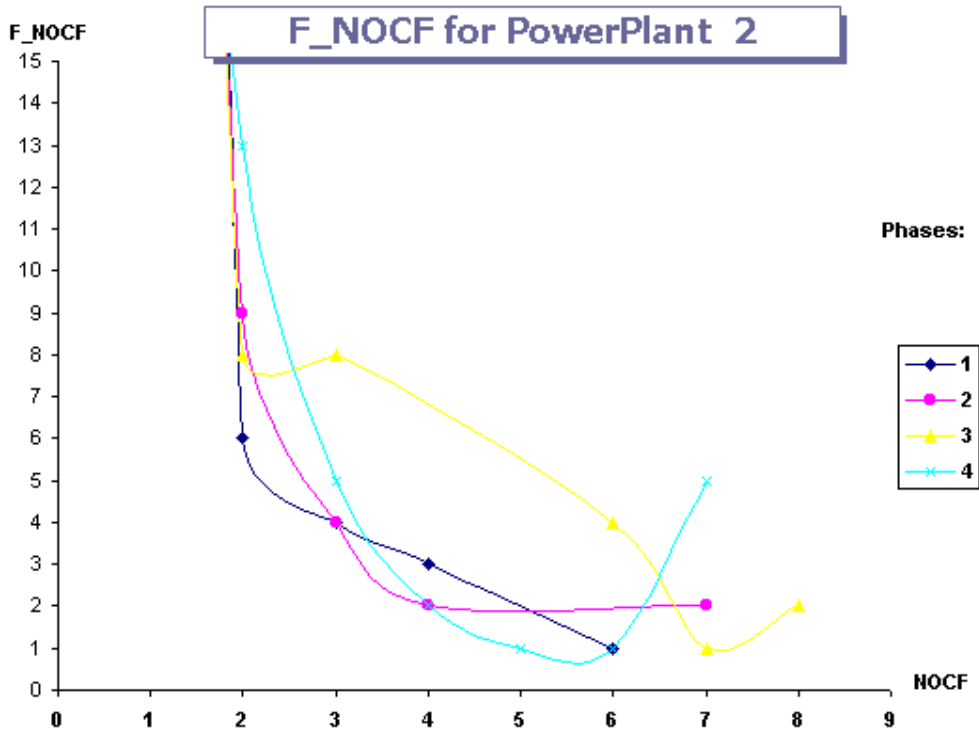

Fig. 8

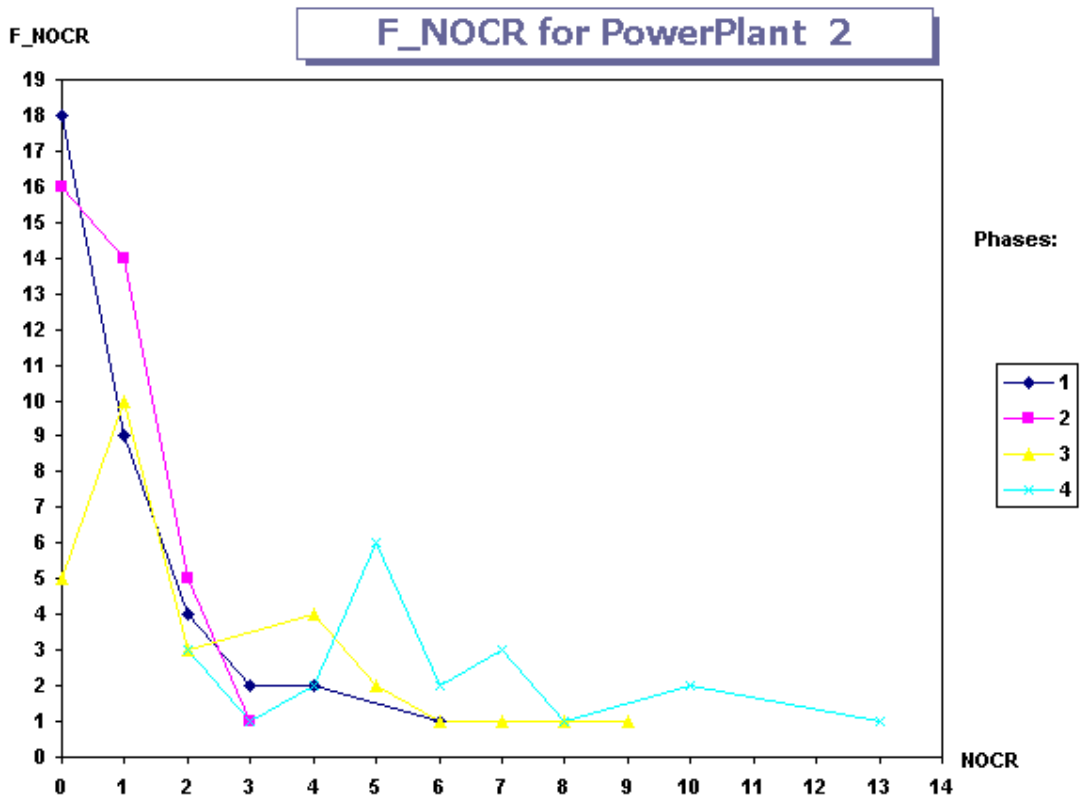

Fig. 9



Above curves are interpretation as below:

- ◆ There is a downward mutation in start points of the curves, that indicates the efficiency of the interventions to the sharing of managers' thought.
- ◆ Downward mutation in start point of phase 3 to phase 2: (16 → 5), indicates the efficiency of shared vision process and also mutation of start point phase 4 to phase 3 [(0,5) → (2,3) ] indicates the high efficiency of shared mental models process.
- ◆ Start point in phase 4 from NOCR=2 is compared with other phases, as it is observed all curves start from NOCR=0 could be interpreted as start point of team learning effectiveness at the level of all managers. Consequently, it means that , shared mental models process ( or mental models management: MMM ) is a technique to implement team learning discipline. In other words an organization have stepped in team learning discipline if start point of curve moves from NOCR= 0 to NOCR ≠0. The higher NOCR, the more effective would be the implementation of team learning. By keen attention, it is seen that team learning (TL) discipline fill the fragmentation between Individual Vision (IV) and Shared Vision (SV) and between Individual Mental Models (IMM) and Shared Mental Models (SMM). Then, (NOCR, F-NOCR) belonging to start point of the curve can be suggested as a ranking measure for learning organizations.
- ◆ Last points of the curves are: 6,3. 9 and 13, show outstanding movement of the curves towards right, that indicates the high efficiency of the interventions in respect to sharing of managers' thoughts.
- ◆ Curve phase 2 to phase 1 show a light changes but it is not by itself meaningful while the downward mutation in start point of phase 3 to phase 2 clearly indicates that, the intervention of Basics has built up a very firm foundation, for the next period.
- ◆ Curves belonging to phases 3&4 passes through a maximum and it can also be seen that the maximum have shifted to the right which indicates the efficiency of shared mental models process.
- ◆ All curves in general and curves belonging to phases 3 & 4 specifically, show the rotation of slope from negative to positive that, indicates the upward trend of sharing based on interventions.

#### **4.3.2.2.3 Curves of power plant 3 (PPID=3)**

The cures of (NOCF, F-NOCF) and (NOCR,F\_NOCR) belonging to power plant 3 are shown and evaluated as follows:

It should be mentioned that in power plant 3 a nine month period, as the first period intervention, for Transfer Of Basics (TOB), was not implemented independently. Another point which should be noticed is that power plant 3 PPID=3 has passed 3 phases and 2 periods compared with power plant 1 and 2 that have passed 4 phases and 3 periods.

#### 4.3.2.2.3.1 Curve of (NOCF, F\_NOCF)

Figure 10 is represented the curves of (NOCF, F\_NOCF).

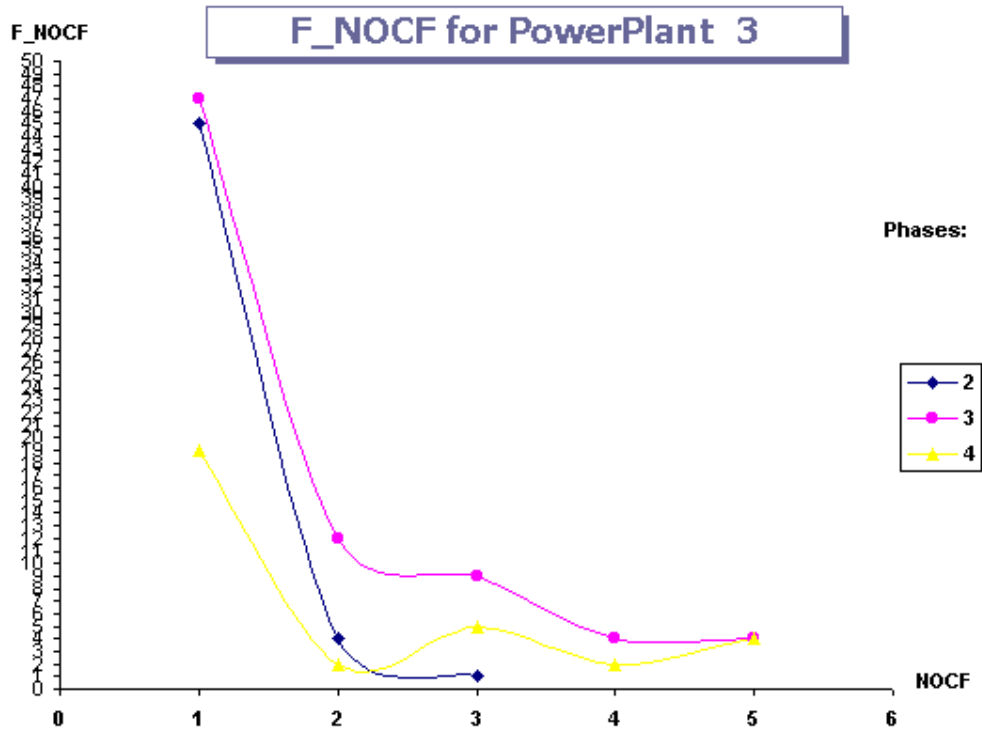

Fig. 10

The above curves can be interpreted as below:

- ◆ Higher starting point of curve in phase 3 to 2 indicates that shared vision process causes a scattering in managers' thought.
- ◆ The curves belonging to phases 2 & 3 show a movement in both rightward and upward directions that indicate efficiency of the intervention of shared vision process.
- ◆ Starting point in curve belonging to phase 4 when compared with phases 2 and 3 show a downward mutation which indicates a high rate convergence have been happened among the managers' thought and the scattering, resulted from shared vision process, has been controlled.
- ◆ In total, curves show a good rotation of the slope from negative to positive that indicates more sharing among managers thought, based on interventions.

#### 4.3.2.2.3.2 Curves of (NOCR, F\_NOCR)

Figure 11 is represented the curves of (NOCR, F\_NOCR).

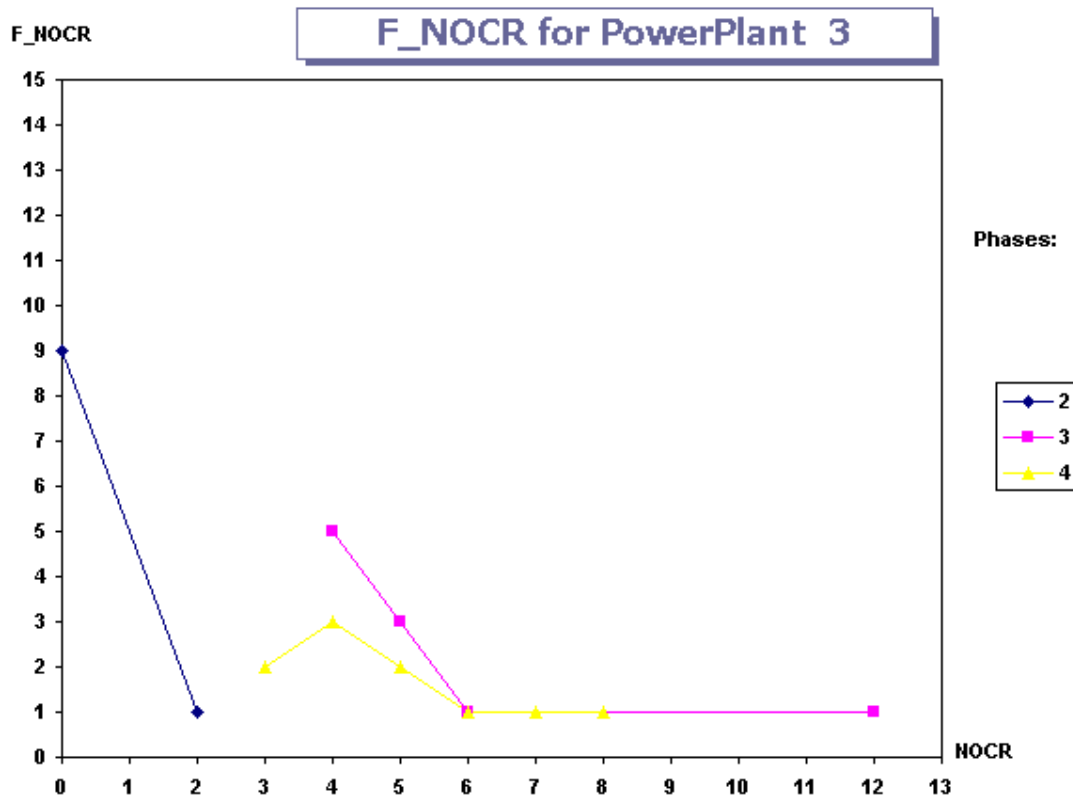

Fig. 11

The above curves can be interpreted as follows:

- ◆ Generally there is an outstanding movement to the right that indicates the interventions has been efficient to share the managers' thought.
- ◆ Curve of phase 2 (belonging to before any interventions) is at the left of the others and it is completely separated from the others, so it indicates an outstanding effectiveness for interventions, totally.
- ◆ Outstanding rightward movement of curve belonging to phase 3 in respect to phase 2 indicates shared vision process played an efficient role in sharing the managers' thoughts.

## 4.4 Conclusions

Regarding to the analysis and evaluation of the tables and the curves in sections 4.3.1 and 4.3.2, the followings are the major results.

1. Generally, implementation of a scientific management model, in an organization is very efficient in alignment of the thoughts and it is a basic action to increase sharing among the individuals.
2. Basics theories of the research, that is: management functions, system dynamics and organisational learning, plays a crucial role in founding and build up a proper, valuable background in managers' thoughts.

3. The shared vision process, in essence, is “idealism” and shared mental model process, in essence, is “pragmatism”.
4. In an organizational level, idealism without pragmatism could be risky. In this regards process of shared vision, alone, leads to thescattering of the thoughts and it could be uncontrollable.
5. ISO award process is categorised in process of shared mental models and it plays an outstanding role in sharing of thoughts among the people.
6. Process of shared mental models is capable to control dispersion and scattering of thoughts, originated from process of shared vision.
7. Processes of shared vision and shared mental models are complementary and it is necessary to be implement, simultaneously. ( In below the simultaneous model is described)

\*\*\*\*\*

# REFERENCES

- Argyris Chris (1999), "On Organizational Learning", Blackwell Publishers Ltd,
- Eden. C. (1992), " On the nature of Cognitive maps ", Journal of management studies, Vol. 29, No. 3. PP. 261 - 265
- Eden. C. (1994), " Cognitive mapping and problem structuring for system dynamics model building ", system Dynamics Review, Vol. 10, Nos. 2-3, PP. 257-276
- Foil. C.M. & Huff A. S. (1992), " Maps for Managers: Where are we? Where do we go from here? ", Journal of management studies, Vol. 29, No. 3, PP. 267-285
- Kim Daniel H. (1993), " A Framework and Methodology for Linking Individual and Organizational Learning: Application In TQM And Product Development ",Ph. D. Dissertation at the MIT
- Kim Daniel H. (Fall 1993), " The Link Between Individual and Organizational Learning," Sloan Management Review ", Vol. 35, No 1, PP. 37-50.
- Langfield-Smith K. & Wirth A. (1992), " Measuring differences between Cognitive Maps," Journal of operational Research society. Vol. 43, No 12, PP. 1135-1150
- Senge Peter M. (Fall 1990)," The Leader's New Work: Building Learning Organizations", Sloan Management Review, PP. 7 - 23.
- Senge Peter M. (1990), " The fifth Discipline: The Art and Practice of the Learning Organization ", Published By Doubleday, USA
- Senge P. M., Kleiner. A. C. Roberts, R. B. Ross and B. J. Smith (July 1994), " The fifth Discipline Fieldbook: strategies and tools for Building a Learning Organization ", Published by Doubleday, New York, USA.
- Stata Ray (1989) "Organizational Learning, The Key To Management Innovation", Sloan Management Review, spring 1989, pp.63-74
- Steven E. Prokesch (1997), "Unlashing the Power of Learning: An Interview with British Petroleum's John Browne", Harvard Business Review, Sep.-Oct. 1997
- Ulengin, F. & Onsel, S.(1997).Cognitive maps of three turkish politicians : The Issue of Privatization, Bogazici Journal Review of Social, Economic and Administrative Studies; Vol. 11;No.1-2; PP. 151-173

\*\*\*\*\*